

---

LOW VOLTAGE AC DRIVES

## **ABB industrial drives**

ACS880, drive modules

0.75 to 3500 HP (0.55 to 3200 kW)





**Reliability, performance and safety.  
ACS880 series.**

# ABB industrial drives

## ACS880, drive modules

### 4 THE ALL-COMPATIBLE ACS880 SERIES

- 6 SIMPLIFY YOUR WORLD WITHOUT LIMITING YOUR POSSIBILITIES
- 8 OPTIMIZED FOR CABINET ASSEMBLY
- 9 EASE OF ENGINEERING AND USE
- 10 VIRTUAL COMMISSIONING
- 11 SMARTER SOLUTIONS WITH DRIVE-BASED FUNCTIONAL SAFETY
- 12 COMPREHENSIVE CONNECTIVITY
- 13 MINIMIZED DOWNTIME
- 14 GLOBAL COMPATIBILITY WITH
- 14 VARIOUS DEMANDS
- 15 PREMIUM CONTROL AND
- 15 PROGRAMMABILITY
- 16 APPLICATION- AND INDUSTRY-SPECIFIC SOLUTIONS

### 18 HOW TO SELECT A DRIVE

### 19 TECHNICAL DATA

### 20 WALL-MOUNTED SINGLE DRIVE MODULES

### 24 SINGLE DRIVE MODULES HIGH POWER SINGLE DRIVE

### 29 REGENERATIVE DRIVE MODULES

### 35 ULTRA-LOW HARMONIC DRIVE MODULES

### 41 AIR-COOLED MULTIDRIVE MODULES LIQUID-COOLED MULTIDRIVE MODULES

### 54 DIMENSIONS

#### OPTIONS

- 59 STANDARD INTERFACE AND EXTENSIONS
- 59 FOR PLUG-IN CONNECTIVITY
- 61 CONTROL PANEL OPTIONS
- 62 ABB SMARTPHONE APPS
- 63 CONNECTIVITY TO AUTOMATION SYSTEMS
- 64 FEEDBACK INTERFACE AND DDCS COMMUNICATION OPTIONS
- 65 REMOTE MONITORING OPTIONS
- 66 PC TOOL OPTIONS
- 67 SAFETY OPTIONS
- 69 EMC – ELECTROMAGNETIC COMPATIBILITY
- 71 SINE FILTERS
- 72 BRAKE OPTIONS
- 77 DU/DT FILTERS

### 80 CHOOSE THE RIGHT MOTOR FOR YOUR APPLICATION

#### ABB DRIVE SERVICES

- 82 KEEP YOUR PROCESS RUNNING
- 84 ABB ABILITY™ DIGITAL POWERTRAIN

### 87 SUMMARY OF FEATURES AND OPTIONS

### ACS880 DRIVE SERIES 4 – 17

### HOW TO SELECT A DRIVE 18

### TECHNICAL DATA 19

### WALL-MOUNTED SINGLE DRIVE MODULES 20 – 22

### SINGLE DRIVE MODULES AND MODULE PACKAGES 23 – 28

### REGENERATIVE DRIVE MODULES 29 – 34

### ULTRA-LOW HARMONIC DRIVE MODULES 35 – 40

### MULTIDRIVE MODULES 41 – 53

### DIMENSIONS 54 – 58

### STANDARD INTERFACE AND EXTENSIONS 59 – 60

### OPTIONS 61 – 79

### MOTORS 80 – 81

### ABB DRIVE SERVICES 82 – 83

### ABB AUTOMATION PRODUCTS

### 84 – 86

### SUMMARY OF FEATURES AND OPTIONS

# The all-compatible ACS880 series

## Reliability and flexibility

The ACS880 is an all-compatible ABB industrial drive, offered in a range of wall-mounted drives, drive modules and cabinet-built drives.

ABB's all-compatible drives are designed to provide customers across industries and applications with unprecedented levels of compatibility and flexibility. The ACS880 drive modules are optimized for panel building. They are customized to meet the particular needs of specific industries, such as oil and gas, mining, metals, chemicals, cement, power plants, material handling, pulp and paper, sawmills, marine, water and wastewater, food and beverage, and automotive. They can control a wide range of applications, including cranes, extruders, winches, winders, conveyors, mixers, compressors, centrifuges, test benches, elevators, extruders, pumps and fans.

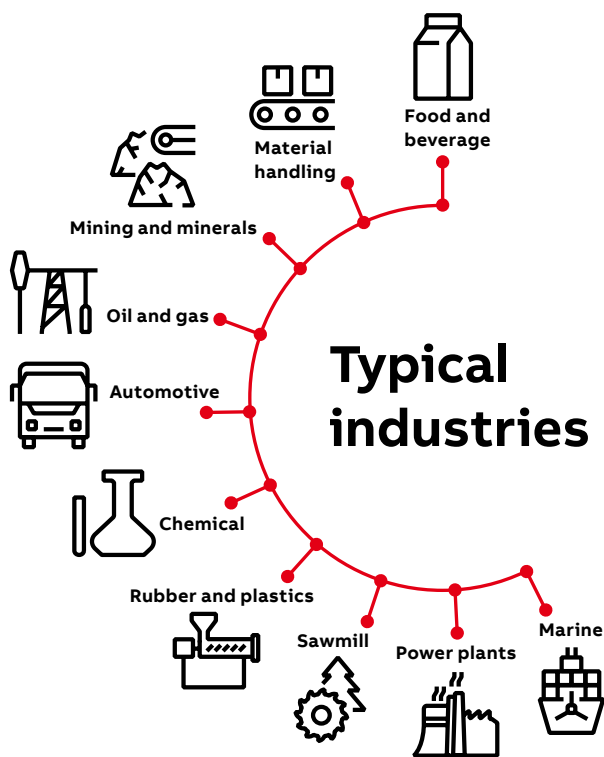

### High quality

#### Reliability and consistent high quality

The ACS880 drives are designed for customers who value high quality and robustness in their applications. They have coated boards as standard, making the ACS880 suitable for harsh conditions. Additionally, every ACS880 drive is factory-tested at full load to ensure maximum reliability. The tests include performance and all protective functions.

#### High performance, safety and configurability

The ACS880 offers the highest level of performance. The drives are equipped with ABB's signature Direct Torque Control (DTC), which provides precise speed and torque control for all applications and supports virtually any type of motor.

The extensive ACS880 offering includes wall-mounted drives, drive modules and cabinet-built drives, as well as low harmonic and regenerative variants.

The ACS880 has all the essential features built-in reducing the time required for engineering, installation and commissioning. A wide range of options are also available to optimize the drive for different requirements, including certified, integrated safety features.





# Simplify your world without limiting your possibilities

The ACS880 industrial drive modules are designed for cabinet installation, with optimized location of the power terminals and wheels for easy maneuvering. A wide selection of module variants and options, including extensive programming and connectivity, make the ACS880 suitable for various different requirements and applications.



## Optimized for cabinet assembly

- Flexible mounting directions and product configurations
- Side-by-side mounting
- Power terminal locations designed for optimal and compact cabinet layout
- High power modules with wheels for easy maneuvering
- Possibility for flange (push through) mounting
- Mechanical kits for easy cabinet assembly

See page 08



## Ease of engineering and use

- All-compatible ACS880 drives share the same easy-to-use user interface
- Multilingual control panel with clear display
- Graphical PC tools for engineering, commissioning and maintenance
- Minimized engineering and installation effort with integrated features and components
- Extensive selection of support material and tools for engineering
- Virtual commissioning

See page 09 – 10



## Smarter solutions with drive-based functional safety

- Safe Torque Off built-in as standard
- Optional safety modules for extended safety functions
- Encoderless safe speed detection
- Highest level of machinery safety, SIL 3 / PL e
- TÜV certified

See page 11



## Comprehensive connectivity

- Communication with all major automation networks
- Remote monitoring
- Mobile connectivity
- Integration tools for various PLCs

See page 12



---

## Nine-year maintenance interval



### Minimized downtime

- Robust, long lifetime design for maximum reliability
- Coated circuit boards for harsh conditions
- Removable memory unit for fast drive replacement
- Each drive factory tested at full load
- Nine-year maintenance interval
- Worldwide service and support
- Advanced features for analyzing and resolving issues

**See page 13**

### Global compatibility with various demands

- Global product approvals, e.g. CE, UL, cUL, CSA, marine certifications, ATEX
- Support for various motor types
- Low harmonic content
- Capable of power regeneration

**See page 14**

### Premium control and programmability

- Direct Torque Control (DTC) for precise control
- Speed, torque and position control as well as synchronizing
- Extensive parameter-based programming
- Adaptive programming as standard
- Drive-based PLC programmability (IEC 61131-3) for fully customized solutions

**See page 15**

### Application and industry specific solutions

- Ready-made optimized solutions for various applications and industries

**See page 16 – 17**

# Optimized for cabinet assembly

## Optimized mechanical design for cabinet assembly

ACS880 drive modules have been optimized for assembly into the customer's own cabinets to ensure high quality and compact installation at minimal cost. High power modules have wheels for easy maneuvering, and the power terminal locations have been designed for optimal and compact cabinet layout. Side-by-side mounting reduces the required cabinet space.

For harsh environments, flange mounting (push through) with UL (NEMA) Type 12 / IP55 back side protection is offered for complete drive modules. In flange mounting, the control electronics are separated from the cooling airflow for better thermal management and higher reliability.

Flexible mounting and cabling directions enable adaptation to various cabinet enclosures. All the complete ACS880 drive modules have UL (NEMA) Type Open / IP20 enclosure class to minimize engineering and assembly effort, as well as to reduce the total cost and ensure a safe ready-made cabinet.

## Support for cabinet assembly

A large variety of support material is available for making cabinet assembly, planning, and implementation as straightforward and rapid as possible. Cabinet assembly accessories help shorten engineering and assembly time, and help to reduce the risk of errors.

A wide selection of both mechanical and electrical installation accessories are offered for high power modules. These accessories are available allowing full design to install the modules into customer enclosures. Additionally, ABB authorized and registered system integrators and panel builders can offer their assistance.





# Ease of engineering and use

## All-compatible user interface saves commissioning and learning time

The ACS880 is part of ABB's all-compatible drives portfolio. Other drives in this portfolio are the ACS380, ACS480 and ACS580.

These drives share the same easy-to-use PC tools and multilingual control panels. To further enhance the user experience they also have the same parameter structure, saving learning and commissioning time.

The drives also share the same communication option modules, simplifying the use of the drives and spare parts required.

## Simplicity at your fingertips as standard

The control panel's assistant helps you setup the drive quickly and effectively. The intuitive, high-contrast, high-resolution display offers easy navigation in multiple languages.

The PC tool for commissioning and configuration provides extensive drive monitoring capabilities, quick access to drive settings, as well as a graphical interface for configuring safety functions, visual control diagrams, and direct links to user manuals.

## Built-in features simplify ordering and installation

All ACS880 drives have an internal choke for harmonic filtering, a Modbus RTU fieldbus interface, and Safe Torque Off functionality as standard. Other built-in features, standard or optional, include EMC filters, brake choppers, du/dt filters, low harmonic or regenerative functionality, various I/O extensions, communication protocol adapters, and functional safety modules.

The built-in features shorten engineering and installation time as well as reduce the risk of errors. As a result, the total cost is lower and the whole drive system is more compact.

## Engineering support

ABB provides an extensive selection of support material and tools to help in engineering, such as:

- Drive sizing tools, e.g. DriveSize
- Step-by-step installation instructions
- E-learning
- Safety circuit design tools
- EPLAN P8 macros
- Selection tool for choosing external components, e.g. fuses and circuit breakers
- Dimensional (2D and 3D) and electrical drawings
- Application guides
- Drive installation and configuration videos

These tools and support from our experts ensure that the drive system can be set up easily and reliably.

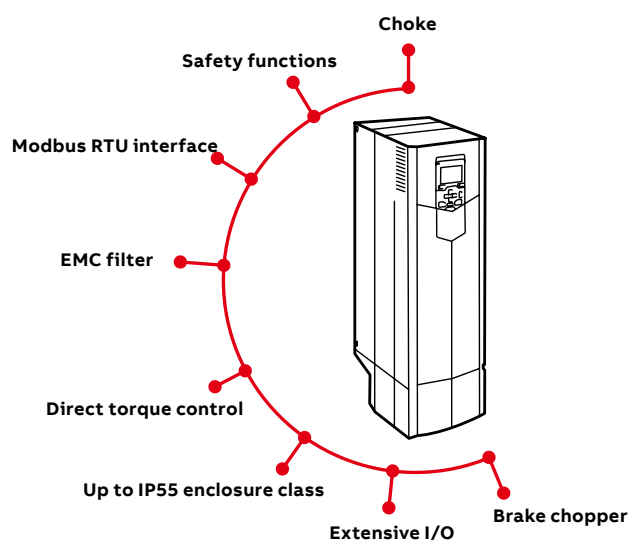

## DriveSize sizing tool for selecting the optimal drive

DriveSize is designed to help select the optimal drive, motor and transformer for the application. Based on data supplied by the user, the tool calculates and suggests which drive and motors to use.

DriveSize is a free software and can be used either online or downloaded for PC from <https://new.abb.com/drives/software-tools/drivesize>.

# Virtual commissioning

Virtual engineering and commissioning allows machine builders and system integrators to develop and simulate entire industrial processing lines and machines, including ABB drives, without actually running the hardware. This gives valuable benefits in the phases of designing, commissioning and operating machines.



## Design safely and efficiently

Engineers can start configuring and programming drives well before receiving them from ABB because the PC software tool, Drive Composer Pro, can be used with virtual and real drives.

Virtualization can include the kinematic and physical behavior of the machine and the overriding automation. Virtual drives can also be used with the ABB Robot Studio tool and ABB Automation Builder programming tools to build more complete virtual machines and processing lines.

After deploying the virtual machine in use on-site, any future improvements can be virtually tested before implementing them in the process. This all supports safety and quality in the engineering process.

- Find and solve potential problems earlier
- Save time and money due to faster drive commissioning
- Assist the sizing and energy optimization of electromechanical drive systems

## Benefits

Throughout the value chain, from sales, marketing, and training to field engineering and product development, virtual commissioning makes drive applications more easily understood and helps to:

- Design, test and learn drive applications virtually with the same software tools used with the actual hardware
- Train users and engineers with application simulation
- Tune drive parameters easily off-site before going into more demanding on-site testing

Save time, reduce risk, and increase engineering productivity

# Smarter solutions with drive-based functional safety

## Maximized safety and conformity

The Safe Torque Off (STO) safety function comes integrated into ACS880 drives. Optional safety functions modules provide an easy way to extend safety functions. These plug-in modules are installed and cabled inside the drive, enabling safety functions and diagnostics in one compact and reliable module. The safety functions are certified by TÜV Nord and comply with the highest performance requirements in machinery safety – SIL 3 / PL e \*).

## Increased productivity by doing things smarter

Safety functions help to minimize unnecessary downtime by keeping the application in control at all times. For example, Safely-Limited Speed (SLS) can keep your process running under safe conditions rather than completely stopping it.

## Flexibility and ease of use

The safety functionality can be scaled to your needs. Ranging from Safe Torque Off (STO) wired to an emergency stop push button, or a complete safety system with PROFIsafe and a safety PLC, e.g. the AC500-S.

Configuring the safety functions module is easy thanks to the graphical user interface in the Drive Composer pro PC tool.

## Available safety functionality

The following safety functions are supported:

- Safe Torque Off (STO)
- Safe stop 1 (SS1-t and SS1-r)
- Safe stop emergency (SSE)
- Safe brake control (SBC)
- Safely-limited speed (SLS)
- Safe maximum speed (SMS)
- Prevention of unexpected startup (POUS)
- Safe direction (SDI)
- Safe speed monitor (SSM)
- Safe motor temperature (SMT)

Integrated safety simplifies configuration

## Safety for explosive atmospheres

ACS880 and ABB Ex motors have been certified as a package providing a safe, proven solution for explosive atmospheres. ACS880 safety options for ATEX environments include:

- ATEX-approved thermistor protection module
- ATEX-approved safe torque off

## TÜV-certified safety design tool

The FSDT-01 functional safety design tool can be used to design complete safety circuits. With this tool it is possible to define required safety integrity (SIL) / performance level (PL) for safety functions, verify achieved safety level and generate design reports.

\*) SIL 2 / PL c for SMT, safe motor temperature.



# Comprehensive connectivity

## Communication with all major automation networks

ACS880 drives come with Modbus RTU fieldbus interface and drive-to-drive communication link as standard.

Plug-in connectivity adapters enable communication with all major industrial automation networks.

The drives support advanced communication features:

- Redundant communication
- PROFIsafe
- Functional safety over fieldbus
- Support for multiple protocols simultaneously
- Shared Ethernet connection for automation communication and Drive Composer PC tool – all communication via the same cable

To minimize connectivity-related risks, cybersecurity is an integral part of the ACS880.

To simplify ACS880's connectivity to automation systems, ABB offers support tools for seamless integration with PLCs from ABB and several other manufacturers.

## Remote monitoring

With a built-in web server and standalone data logger, the NETA-21 remote monitoring tool enables secure worldwide access to your drives.

Drive data can also be collected via a 3G mobile connection with the RMDE reliability monitoring device.

Better connectivity and user experience



## Mobile connectivity

The drive has a Bluetooth control panel enabling easy connection to mobile devices.

ABB offers several smartphone applications, including Drivetune and Drivebase, to ease and enhance the use of ABB drives. These tools provide an easy-to-use approach for commissioning, servicing and using ABB drives.

## Drive mobile apps

- Full access to parameters
- Backup and restore functionality
- Access to drive data and service history
- Ability to share configuration files via e-mail or Bluetooth
- Easy support package creation for faster remote support

# Minimized downtime

## Robust, long life time design

The ACS880 is designed to last for a long time, even in harsh conditions. The benefits include a nine-year maintenance interval and good tolerance for vibrations and contamination.

Several design features make the ACS880 a safe choice:

- Coated circuit boards
- Minimized airflow through the control board section
- Designed for ambient temperatures up to 55 °C
- Advanced protections – e.g. faster and more accurate IGBT protection using a thermal model

Each ACS880 drive unit is tested in the factory at full load to ensure maximum reliability. Continuous quality improvements are made based on the results of accelerated lifetime testing.

## Removable memory unit

The memory unit stores the drive software and settings, including motor data. This unit can be switched from one drive to another, allowing simple and rapid drive replacement without any special equipment, software loading, parameter settings, or other adjustments in the drive or automation system. It also eliminates the risk of software incompatibility. The new drive is ready to run as soon as the memory unit is plugged in.

Nine-year maintenance interval



## Advanced features for analyzing and resolving issues

The ACS880 has timers and counters that can be configured to remind you when the drive or process equipment needs maintenance.

Accurate and reliable diagnostic information is available for warning and fault messages. Help texts give detailed information about the warning or fault. Data loggers store critical values before and during an event. The real-time clock allows you to see the exact times of events.

For faster remote support, all relevant drive data and changed parameters can be saved in a single file package that you can easily create with the Drive Composer PC tool or by creating a QR code with the control panel.

## Global support

ABB offers worldwide support via its extensive pre- and post-sales network, structured to make sure that you have the experts you need close by, locally and globally. See pages 86-83.



# Global compatibility with various demands

## Global product approvals

The ACS880 is a global product and has all the major global approvals, including CE, UL, cUL, EAC, RCM and TÜV. Marine approval, ATEX and SEMI F47 are available either as standard or as an option.

## Support for different motor types

The ACS880 provides reliable control for squirrel cage, high-torque or servo-type permanent magnet, synchronous reluctance (SynRM), submersible and high-speed motors. Most encoder types are supported.

Regardless of the motor type, drive commissioning is easy, with no need for laborious manual tuning.

## Low harmonic content

All ACS880 drives have an internal choke for harmonic reduction. If lower harmonic content is needed, an ultra-low harmonic variant is available. The drive will produce exceptionally low harmonic content and meet the requirements IEE519, IEC61000-3-12 and G5/4.

## Regeneration of energy

The ACS880 offers a number of solutions for applications where electrical braking is needed. As standard, ACS880 drives have a flux braking feature that provides greater deceleration by increasing the motor flux. If this is not sufficient, the internal brake chopper can be used together with a brake resistor.

The most advanced solution is the ACS880 regenerative drive, which allows full, continuous braking and can produce remarkable energy savings.

ACS880 also supports common DC bus configurations, where the braking energy from one load can be utilized by other loads.



# Premium control and programmability

## Direct Torque Control (DTC)

ABB's state of the art motor control technology provides precise speed and torque control, with or without an encoder, even close to zero speed. DTC provides reliable starts and rapid reactions to load or line changes, and ensures smooth and continuous operation. DTC provides optimal control, even with sine filters.

The energy optimizer feature maximizes motor efficiency by ensuring maximum torque per ampere, reducing the power drawn from the supply.

## Position control and synchronizing

Position control allows to meet motion systems demands without the need of an external position controller. The ready-made motion functions can be easily configured by parameters.

Additional features, such as built-in synchronized drive to drive link and possibility for encoderless positioning, make ACS880 position control ideal for any axis.

## Drive programming

To meet your specific application needs, you can customize your ACS880 with an extensive range of user-definable software settings (parameters) and adaptive programming.

This makes fine-tuning the ready-made application control program easy. For further customization, drive application programming based on IEC 61131 standard is available for full PLC programmability. IEC programming uses the same programming environment as ABB PLCs. It is also easy to integrate the ACS880 with PLCs and HMIs.

**Adaptive programming** is an easy to use dynamic programming which allows flexible adjustments to the ACS880 software.

## IEC programming

based on IEC 61131 standard for full scale PLC programmability is available as an option.

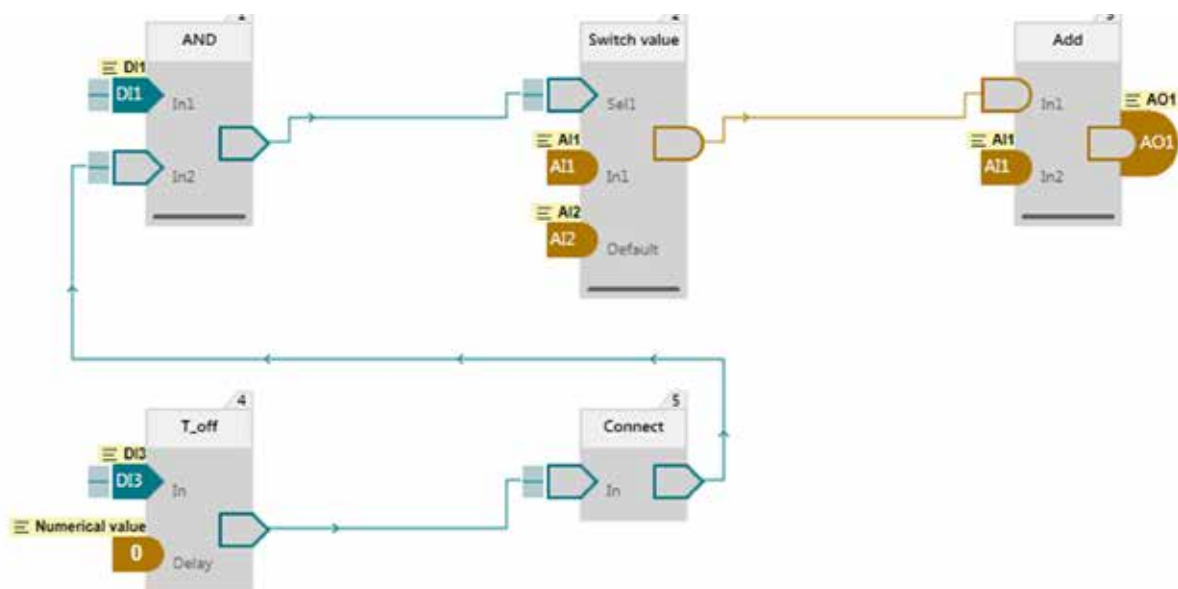

# Application- and industry-specific solutions

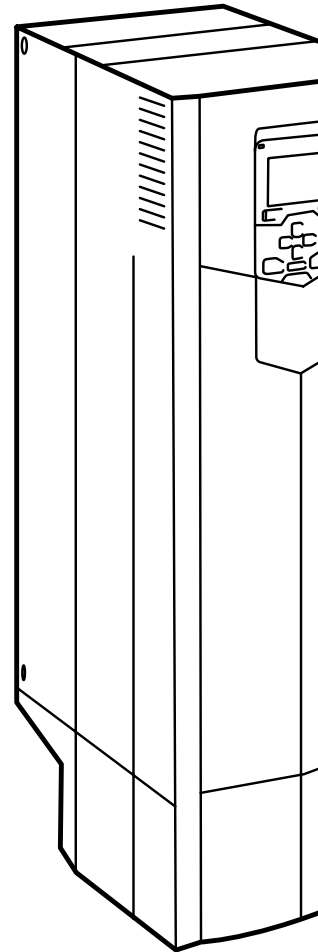
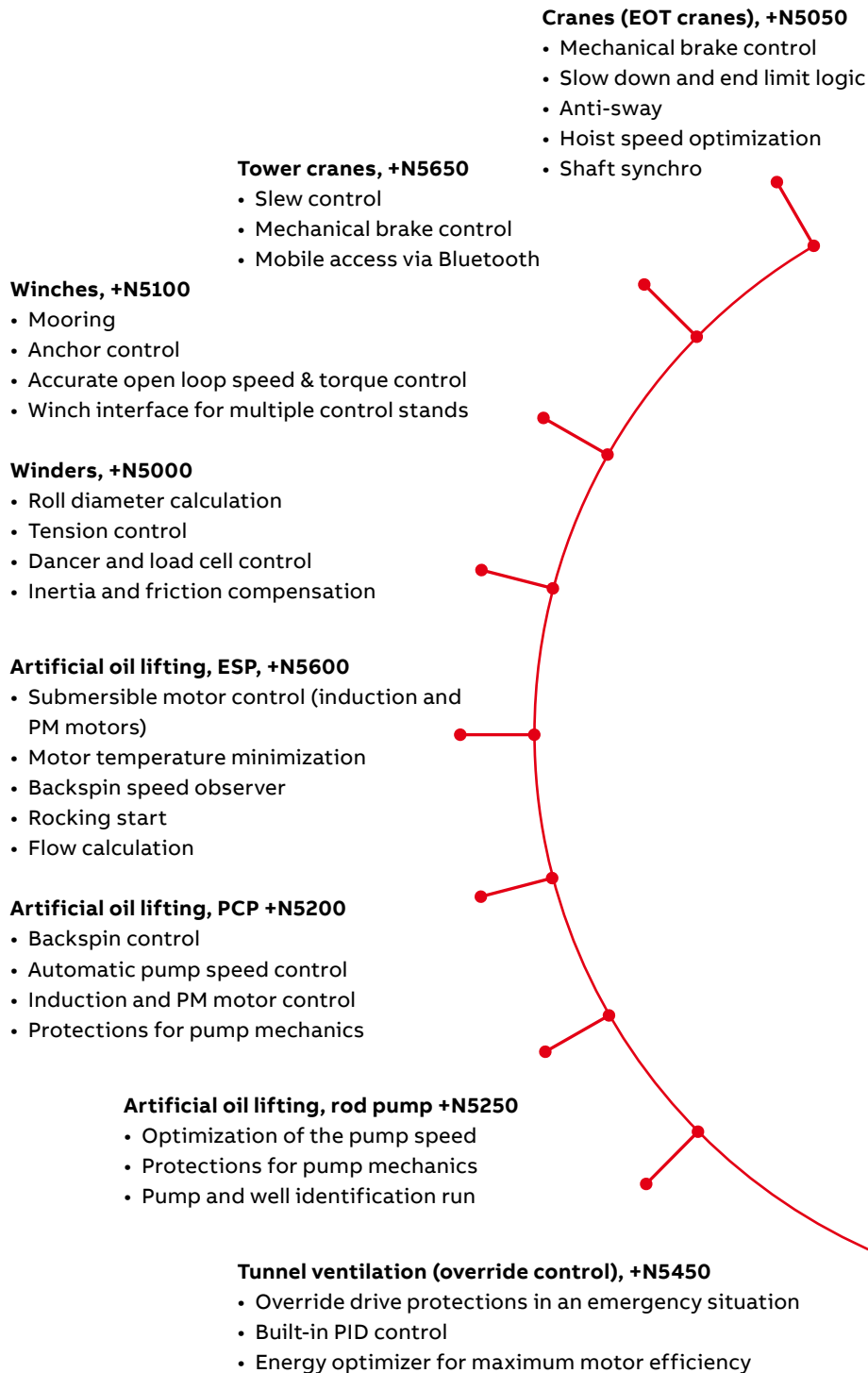

By working closely with customers over many years, ABB has developed application control programs and specific software features for specific applications and industries. This results in programs and features that include lessons learned from any customers, and that are designed to give you the flexibility to adapt the programs to your specific needs.

#### Advantages:

- Enhanced application usability
- Lower energy consumption
- Increased safety
- Reduced need for PLCs
- Protected machinery
- Optimized application productivity
- Optimized time usage and lower operational costs

#### Position control, +N5700

- Ready-made motion control functions
- Synchronized drive to drive link

#### Textile (spinning), +N5500

- Wobulation function
- Manual/auto off function
- Production history

#### Test bench, +N5300

- Fast communication
- High torque accuracy and linearity
- Acceleration damping
- Minimized motor noise

#### Centrifuge, decanter, +N5150

- Accurate speed and torque control, even without an encoder
- Speed difference control of scroll drives for decanters

#### Cooling tower, +N5350

- Support for slow, high-torque cooling tower motors
- Trickle current to keep the motor warm and dry, preventing condensation and icing
- Anti-windmill function

#### Chemical industry

- Direct torque control with sine filters
- Nine-year service interval
- Functionality that conforms with NAMUR requirements

#### Explosive atmospheres

- Type approval with ABB Ex motors
- ATEX-approved safe torque off, STO (+Q971) and thermistor protection module (+L537)

#### Marine

- Type approval from various key classification bodies (+C132)
- Optimal grid control (+N8053)
- Product certification process
- 440 V variant

# How to select a drive

The right drive is extremely easy to select. The following instructions show you how to order the right drive for your application.

Start by identifying your supply voltage and select the related rating table. Or use ABB's DriveSize sizing tool.

Select your drive's order code (drive type) from the rating table based on the load current, or, if it is unknown, select the drive based on your motor's power and current ratings.

**Ratings, types and voltages ACS880-01+P940/P944**

**U<sub>N</sub> 230 V (range 208 to 240 V). The power ratings are valid at nominal voltage 230 V (0.95 to 1% slip).**

Drive type	Frame size	Rated current I <sub>N</sub> (A)	Rated power P <sub>N</sub> (kW)	Light overload I <sub>L</sub> (A)	Heavy-duty I <sub>H</sub> (A)	Note level (dB(A))	Heat dissipation (W)	MP flow (l/min)			
ACS880-01-04A2-2	R1	4.6	6.3	6.3	4.4	0.75	3.7	0.55	46	73	44
ACS880-01-04A2-3	R1	5.6	7.8	1.1	6.3	1.1	2.4	0.76	46	83	44
ACS880-01-04A2-4	R1	7.5	11.2	1.5	7.1	1.5	3.3	1.1	46	102	44
ACS880-01-04A2-5	R1	10.0	14.0	2.2	10.1	2.2	4.5	1.5	46	132	44
ACS880-01-04A2-6	R2	16.8	18.0	4.0	16.0	4.0	6.6	2.2	51	232	88
ACS880-01-04A2-7	R2	24.3	28.6	5.5	23.1	5.5	9.8	4	51	337	88
ACS880-01-04A2-8	R3	36.0	41	7.5	34.3	7.5	14.1	6	62	487	134
ACS880-01-04A2-9	R4	46	64	11	44	11	18	7.5	62	500	134
ACS880-01-04A2-10	R4	61	76	15	58	15	25	11	62	630	280
ACS880-01-04A2-11	R5	75	104	18.5	71	18.5	31	15	62	680	280
ACS880-01-04A2-12	R6	105	148	26	100	26	43	20	67	840	435
ACS880-01-04A2-13	R6	145	178	37	138	37	60	30	67	940	435
ACS880-01-04A2-14	R7	200	247	46	189	46	84	40	67	1260	650
ACS880-01-04A2-15	R7	266	287	65	256	65	116	55	67	1500	650
ACS880-01-04A2-16	R8*	378	380	95	360	95	161	80	65	2100	550

**U<sub>N</sub> 400 V (range 380 to 415 V). The power ratings are valid at nominal voltage 400 V (0.95 to 200% slip).**

Drive type	Frame size	Rated current I <sub>N</sub> (A)	Rated power P <sub>N</sub> (kW)	Light overload I <sub>L</sub> (A)	Heavy-duty I <sub>H</sub> (A)	Note level (dB(A))	Heat dissipation (W)	MP flow (l/min)			
ACS880-01-02A3-2	R1	2.4	3.1	0.75	2.3	0.75	1.8	0.55	46	30	44
ACS880-01-02A3-3	R1	3.3	4.1	1.1	3.1	1.1	2.4	0.76	46	37	44
ACS880-01-02A3-4	R1	4.0	5.6	1.5	3.8	1.5	3.3	1.1	46	52	44
ACS880-01-02A3-5	R1	5.6	6.8	2.2	5.3	2.2	4.5	1.5	46	71	44
ACS880-01-02A3-6	R1	8.0	9.5	3	7.4	3	5.4	2.2	46	84	44
ACS880-01-02A3-7	R1	10	12.2	4	9.5	4	7.4	3	46	102	44
ACS880-01-02A3-8	R1	13.8	16	5.5	12.3	5.5	10	4	46	132	44
ACS880-01-02A3-9	R2	17	21	7.5	16	7.5	12.6	5.5	51	232	88
ACS880-01-02A3-10	R2	25	29	11	24	11	17	7.5	51	337	88
ACS880-01-02A3-11	R3	33	40	15	30	15	23	11	62	487	134
ACS880-01-02A3-12	R3	38	54	18.5	36	18.5	32	15	62	562	134
ACS880-01-02A3-13	R4	46	64	22	43	22	38	18.5	62	627	134
ACS880-01-02A3-14	R4	61	76	30	58	30	45	22	62	807	280
ACS880-01-02A3-15	R5	87	102	45	83	45	72	30	62	1120	280
ACS880-01-02A3-16	R6	105	148	55	100	55	97	40	67	1290	435
ACS880-01-02A3-17	R6	145	178	76	138	76	135	55	67	1440	435
ACS880-01-02A3-18	R7	200	247	90	181	90	145	70	67	1840	650
ACS880-01-02A3-19	R7	266	287	120	256	120	185	90	67	2100	650
ACS880-01-02A3-20	R8	345	350	150	324	150	230	110	65	3300	550
ACS880-01-02A3-21	R8*	393	400	180	360	180	267	130	65	3900	550
ACS880-01-02A3-22	R8*	503	498	200	440	200	340	160	68	4800	1150
ACS880-01-02A3-23	R9*	630	540	250	600	250	380	200	68	6000	1150

**Ratings, types and voltages ACS880-01+P940/P944**

**U<sub>N</sub> 230 V (range 208 to 240 V). The power ratings are valid at nominal voltage 230 V (0.95 to 1% slip).**

Drive type	Frame size	Rated current I <sub>N</sub> (A)	Rated power P <sub>N</sub> (kW)	Light overload I <sub>L</sub> (A)	Heavy-duty I <sub>H</sub> (A)	Note level (dB(A))	Heat dissipation (W)	MP flow (l/min)			
ACS880-01-04A2-2	R1	4.6	6.3	6.3	4.4	0.75	3.7	0.55	46	73	44
ACS880-01-04A2-3	R1	5.6	7.8	1.1	6.3	1.1	2.4	0.76	46	83	44
ACS880-01-04A2-4	R1	7.5	11.2	1.5	7.1	1.5	3.3	1.1	46	102	44
ACS880-01-04A2-5	R1	10.0	14.0	2.2	10.1	2.2	4.5	1.5	46	132	44
ACS880-01-04A2-6	R2	16.8	18.0	4.0	16.0	4.0	6.6	2.2	51	232	88
ACS880-01-04A2-7	R2	24.3	28.6	5.5	23.1	5.5	9.8	4	51	337	88
ACS880-01-04A2-8	R3	36.0	41	7.5	34.3	7.5	14.1	6	62	487	134
ACS880-01-04A2-9	R4	46	64	11	44	11	18	7.5	62	500	134
ACS880-01-04A2-10	R4	61	76	15	58	15	25	11	62	630	280
ACS880-01-04A2-11	R5	75	104	18.5	71	18.5	31	15	62	680	280
ACS880-01-04A2-12	R6	105	148	26	100	26	43	20	67	840	435
ACS880-01-04A2-13	R6	145	178	37	138	37	60	30	67	940	435
ACS880-01-04A2-14	R7	200	247	46	189	46	84	40	67	1260	650
ACS880-01-04A2-15	R7	266	287	65	256	65	116	55	67	1500	650
ACS880-01-04A2-16	R8*	378	380	95	360	95	161	80	65	2100	550

**U<sub>N</sub> 400 V (range 380 to 415 V). The power ratings are valid at nominal voltage 400 V (0.95 to 200% slip).**

Drive type	Frame size	Rated current I <sub>N</sub> (A)	Rated power P <sub>N</sub> (kW)	Light overload I <sub>L</sub> (A)	Heavy-duty I <sub>H</sub> (A)	Note level (dB(A))	Heat dissipation (W)	MP flow (l/min)			
ACS880-01-02A3-2	R1	2.4	3.1	0.75	2.3	0.75	1.8	0.55	46	30	44
ACS880-01-02A3-3	R1	3.3	4.1	1.1	3.1	1.1	2.4	0.76	46	37	44
ACS880-01-02A3-4	R1	4.0	5.6	1.5	3.8	1.5	3.3	1.1	46	52	44
ACS880-01-02A3-5	R1	5.6	6.8	2.2	5.3	2.2	4.5	1.5	46	71	44
ACS880-01-02A3-6	R1	8.0	9.5	3	7.4	3	5.4	2.2	46	84	44
ACS880-01-02A3-7	R1	10	12.2	4	9.5	4	7.4	3	46	102	44
ACS880-01-02A3-8	R1	13.8	16	5.5	12.3	5.5	10	4	46	132	44
ACS880-01-02A3-9	R2	17	21	7.5	16	7.5	12.6	5.5	51	232	88
ACS880-01-02A3-10	R2	25	29	11	24	11	17	7.5	51	337	88
ACS880-01-02A3-11	R3	33	40	15	30	15	23	11	62	487	134
ACS880-01-02A3-12	R3	38	54	18.5	36	18.5	32	15	62	562	134
ACS880-01-02A3-13	R4	46	64	22	43	22	38	18.5	62	627	134
ACS880-01-02A3-14	R4	61	76	30	58	30	45	22	62	807	280
ACS880-01-02A3-15	R5	87	102	45	83	45	72	30	62	1120	280
ACS880-01-02A3-16	R6	105	148	55	100	55	97	40	67	1290	435
ACS880-01-02A3-17	R6	145	178	76	138	76	135	55	67	1440	435
ACS880-01-02A3-18	R7	200	247	90	181	90	145	70	67	1840	650
ACS880-01-02A3-19	R7	266	287	120	256	120	185	90	67	2100	650
ACS880-01-02A3-20	R8	345	350	150	324	150	230	110	65	3300	550
ACS880-01-02A3-21	R8*	393	400	180	360	180	267	130	65	3900	550
ACS880-01-02A3-22	R8*	503	498	200	440	200	340	160	68	4800	1150
ACS880-01-02A3-23	R9*	630	540	250	600	250	380	200	68	6000	1150

**Control panel options**

**Standard Bluetooth assistant control panel, ACS-AP-W and Industrial assistant control panel, ACS-AP-I**

Assistant control panel with clear multilingual graphical display can be used for parameter setting and back-up, drive monitoring and operation, fault tracing and as a USB link to a PC tool. There are two different assistant control panels – with (ACS-AP-W) or without (ACS-AP-I) Bluetooth. The panels can be mounted either on the drive or on the door of the inverter and they are compatible with any ABB A1-compatible drive.

Control panel helps you to set up the essential settings quickly and get the drive into action. Also diagnostic is easy due to event history, clear text messages and realtime stamps.

**Control panel mounting platform, DPH4-01**

For surface mounting and has IP65 / UL Type 12 protection class (IP20, when control panel not mounted).

**Control panel mounting platform, DPH4-02**

For surface mounting and has IP65 / UL Type 12 protection class (IP20, when control panel not mounted).

Option code	Ordering code	Description	Type
02A01-1	3A05000000000000	Bluetooth assistant control panel ** (included as standard for ACS-AP-I, UL175 and ACS880-01-DMP up to frame size R1)	ACS-AP-W
02A01-2	3A05000000000000	Bluetooth assistant control panel without Bluetooth connection	ACS-AP-I
02A01-3	3A05000000000000	Control panel mounting platform, flush mounted, IP65 / UL Type 12 protection class (IP20, when control panel not mounted)	DPH4-01
02A01-4	3A05000000000000	Control panel mounting platform, surface mounted, IP65 / UL Type 12 protection class (IP20, when control panel not mounted)	DPH4-02

\*The codes are valid for ACS880-01/UL175/UL175D/UL175D up to frame size R1.

Choose your options and add the option codes to the drive's order code. Remember to use a "+" mark before each option code.

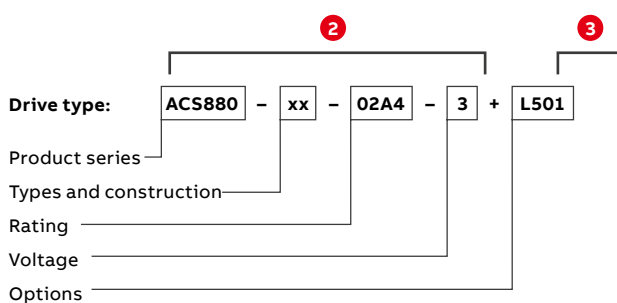



# Technical data

## Mains connection

Voltage and power range	3-phase, $U_{N2}$ 208 to 240 V, +10%/-15% (-01) 3-phase, $U_{N5}$ 380 to 500 V, +10%/-15% (-01, -04, -04F, -11, -31, -14, -34) 3-phase, $U_{N7}$ 525 to 690 V, +10%/-15% (-01, -04, -04F, -14, -34) 3-phase, $U_{N5}$ 380 to 500 V, $\pm 10\%$ (-x04, -x4 <sup>3)</sup> ) 3-phase, $U_{N7}$ 525 to 690 V, $\pm 10\%$ (-x04, -x04LC, -x4 <sup>3)</sup> ) ACS880-01, -04, -04F, -11, -31, -14, -34, -x4 <sup>3)</sup> , -104, -104LC: 0.75 to 3500 HP (0.55 to 3200 kW) Diode supply unit (DSU) 55 to 5445 kVA IGBT supply unit (ISU) 5.5 to 3679 kVA Regenerative rectifier unit (RRU) 400 to 4135 kVA
Frequency	50/60 Hz $\pm 5\%$
Power factor	
ACS880-01, -04, -04F	$\cos\phi = 0.98$ $\cos\phi$ total = 0.93 to 0.95
ACS880-11, -31, -14, -34	$\cos\phi = 1$
IGBT supply unit (ISU)	$\cos\phi = 1$ $\cos\phi$ total = 0.99
Diode supply unit (DSU) and Regenerative rectifier unit (RRU)	$\cos\phi = 0.98$ $\cos\phi$ total = 0.93 to 0.95
Efficiency (at nominal power)	ACS880-01, -04, -04F, -104, DSU, RRU: 98%. ACS880-11, -31, -14, -34, ISU: 97%

## Motor connection

Voltage	3-phase output voltage 0 to $U_{N2}/U_{N5}/U_{N7}$
Frequency	0 to $\pm 598$ Hz <sup>1)</sup>
Motor control	Direct torque control (DTC)
Torque control	Torque step rise time:
Open loop	<5 ms with nominal torque
Closed loop	<5 ms with nominal torque
	Non-linearity:
Open loop	$\pm 4\%$ with nominal torque
Closed loop	$\pm 3\%$ with nominal torque
Speed control	Static accuracy:
Open loop	10% of motor nominal slip
Closed loop	0.01% of nominal speed
	Dynamic accuracy:
Open loop	0.3 to 0.4% seconds with 100% torque step
Closed loop	0.1 to 0.2% seconds with 100% torque step

## Product compliance

CE  
Low Voltage Directive 2014/35/EU according to EN 61800-5-1:2007  
Machinery Directive 2006/42/EC  
EMC Directive 2014/30/EU  
ATEX Directive 2014/34/EU, EN 50495  
Quality assurance system ISO 9001 and Environmental system ISO 14001  
RoHS 2011/65/EU and Delegated Directive (EU) 2015/836  
cULus listed according to UL508C or UL 61800-5-1 and CSA C22.2 No. 274,  
CSA Certified according to CSA C22.2 No. 274  
RCM, EAC<sup>4)</sup>  
TÜV Nord certification for functional safety<sup>5)</sup>  
ATEX-certified safe disconnection function and thermistor protection function, Ex II (2) GD<sup>7)</sup>  
Marine type approvals for -01: ABS, Bureau veritas, CCS, DNV GL, KR, Lloyd's, NK, RINA, RMRS. For other modules, see <http://new.abb.com/drives/segments/marine/marine-type-approvals>.

## EMC according to EN 61800-3: 2004 + A1: 2012. See page 69.

1<sup>st</sup> environment category C2 included as option (-01, -04, -04F, -x4<sup>3)</sup>, -11<sup>9)</sup>, -31<sup>9)</sup>, -14, -34, -x04).  
2<sup>nd</sup> environment category C3 included as standard (-x04, -x04LC, -x4<sup>3)</sup>)  
2<sup>nd</sup> environment category C3 included as option (-01, -04, -04F, -11, -31, -x4<sup>2) 3)</sup>, -14, -34)  
2<sup>nd</sup> environment category C4 included as standard

## Environmental limits

Ambient temperature	
Transport	-40 to +70 °C
Storage	-40 to +70 °C
Operation area (air-cooled)	-15 to +40 °C as standard (-01, -04, -04F, -11, -31, -14, -34) 0 to +40 °C as standard (-x04, -x4 <sup>3)</sup> ) +40 to +55 °C with derating of 1%/1 °C (-01, -04, -04F, -11, -31, -14, -34) +40 to +50 °C with derating of 1%/1 °C (-x04, -x4 <sup>3)</sup> )
(liquid-cooled)	0 to +45 °C as standard (-x04LC) +45 to +55 °C with derating of 0,5%/1 °C (-x04LC)
Cooling method	
Air-cooled	Dry clean air
Liquid-cooled	Direct liquid cooling, Antifrogen® L Incoming coolant temperature to module (x04LC): 0 to +40 °C as standard +40 to +45 °C with derating of 2%/1 °C +45 to +50 °C with derating of 2%/1 °C or 6%/1 °C <sup>8)</sup> Incoming coolant temperature to optional liquid-cooling unit (-1007LC) (fresh water or sea water): 0 to +36 °C as standard +36 to +46 °C with derating of 2%/1 °C
Altitude	
0 to 3,280 ft (1,000 m)	Without derating
3,280 to 13,120 ft (1,000 to 4,000 m)	With derating of 1%/328 ft (100 m) <sup>6)</sup>
Relative humidity	5 to 95%, no condensation allowed
Degree of protection	
UL (NEMA) Type	-x4 <sup>3)</sup> , -x04, -x04LC
Open / IP00	
UL (NEMA) Type	-01, -04, -04F, -11, -31, -14, -34
Open / IP20	
Paint color	RAL 9017/9002
Pollution degree	PD 2
Contamination levels	No conductive dust allowed
Storage	IEC 60721-3-1:1997, Class 1C2 (chemical gases), Class 1S2 (solid particles) <sup>1)</sup>
Operation	IEC 60721-3-3:2002, Class 3C2 (chemical gases), Class 3S2 (solid particles) <sup>1)</sup>
Transportation	IEC 60721-3-2:1997, Class 2C2 or 3C2 (chemical gases), Class 2S2 (solid particles without air inlet filters) <sup>1)</sup>

## Built-in functional safety. See pages 67 - 68.

For safe torque off EN/IEC 61800-5-2, IEC 61508: SIL 3, (STO) and IEC 61511: SIL 3, EN/IEC 62061: SIL CL 3, safety functions EN ISO 13849-1: PL e - TÜV Nord certified<sup>8)</sup> module  
Safety over PROFIsafe over PROFINET, certified.  
fieldbus

<sup>1)</sup> C = Chemically active substances, <sup>2)</sup> S = Mechanically active substances

<sup>3)</sup> For higher operational output frequencies please contact your local ABB office.

Operation above 120 Hz might require type specific derating, please contact your local ABB office.

Output filters may limit the output frequency. See product specific hardware manual for details.

<sup>2)</sup> Please check availability per drive type

<sup>3)</sup> Single drive module packages ACS880-04, -14 and -34 which consist of several modules

<sup>4)</sup> EAC directives: TR CU 020/2011 (EMC directive); TR CU 004/2011 (low voltage directive) EAC has replaced GOST R

<sup>5)</sup> For available certificates, see <http://new.abb.com/drives/functional-safety>

<sup>6)</sup> Derating reduced by lower than 40 °C ambient temperature

<sup>7)</sup> Safe disconnection function (+Q971), thermistor protection function (+L537)

<sup>8)</sup> See product specific hardware manual for detailed derating rules.

<sup>9)</sup> Please check availability for -11 and -31 same size

# Wall-mounted single drive modules

## ACS880-01+P940/P944



- 01 ACS880-01+P490 with flange mounting
- 02 ACS880-01+P940
- 03 ACS880-01+P944

### Easy engineering and cabinet assembly

ACS880-01 drives have all the essential features built-in. These standard and optional features include a choke for harmonic filtering, brake chopper, EMC filter, communication protocol adapters, functional safety and I/O extension modules. The built-in design simplifies engineering and installation reducing the total cost and risk of errors. One complete package, together with side-by-side mounting, reduces the required cabinet space.

Flange (push through) mounting with UL (NEMA) Type 12 / IP55 heat sink is available making ACS880-01 ideal for harsh environments. Flange mounting allows for a majority of the heat to disperse outside the enclosure, reducing the need for several large fans to cool the drive module.

### Wall-mounted single drive modules, ACS880-01+P940/P944

- Power ratings: 0.75 to 350 HP (0.55 to 250 kW)
- Enclosure classes: UL (NEMA) Type Open / IP20, in flange mounting, heat sink side UL (NEMA) Type 12 / IP55 for dusty and wet environments

#### Main options:

- Flange mounting
- C2 and C3 EMC filters, see page 69
- Brake chopper (as standard in frames R1 to R4), see page 72
- Brake resistor, see page 72
- Marine type approval from various key classification bodies
- I/O extension modules, see page 63
- Communication protocol adapters, see page 63
- Speed feedback interfaces, see page 64
- Functional safety modules, see page 67
- Remote monitoring options, see page 65
- Application specific software, see page 16
- Du/dt filters, see page 77
- Sine filters, see page 71

The drives have an extensive selection of built-in features and options. See page 87.

### Highlights

- Robust and reliable design with UL (NEMA) Type Open / IP20 enclosure class
- Compact, single package with all the essential features built-in
- Side-by-side mounting
- Flange (push through) mounting
- Incoming air temperature measurement for protecting the drive
- Available with marine type approval
- Tools and documents (EPLAN macros, line apparatus selection tool) to support engineering

# Ratings, types and voltages

## ACS880-01+P940/P944

$U_N = 240 \text{ V}$  (range 208 to 240 V). The power ratings are valid at nominal voltage 230 V.

Drive type	Frame size	Light-duty use			Heavy-duty use			Noise level	Heat dissipation	Air flow
		$I_{Ld}$ [A]	$P_{Ld}$ [HP]	$P_{Ld}$ [kW]	$I_{Hd}$ [A]	$P_{Hd}$ [HP]	$P_{Hd}$ [kW]			
ACS880-01-04A6-2	R1	4.4	1	0.75	3.7	0.75	0.55	46	249 (73)	26 (44)
ACS880-01-06A6-2	R1	6.3	1.5	1.1	4.6	1	0.75	46	321 (94)	26 (44)
ACS880-01-07A5-2	R1	7.1	2	1.5	6.6	1.5	1.1	46	416 (122)	26 (44)
ACS880-01-10A6-2	R1	10.1	3	2.2	7.5	2	1.5	46	587 (172)	26 (44)
ACS880-01-16A8-2	R2	16	5	4	10.6	3	2.2	51	792 (232)	52 (88)
ACS880-01-24A3-2	R2	23.1	7.5	5.5	16.8	5	4	51	1150 (337)	52 (88)
ACS880-01-031A-2	R3	29.3	10	7.5	24.3	7.5	5.5	57	1559 (457)	79 (134)
ACS880-01-046A-2	R4	44	15	11	38	10	7.5	62	1706 (500)	79 (134)
ACS880-01-061A-2	R4	58	20	15	45	15	11	62	2150 (630)	165 (280)
ACS880-01-075A-2	R5	71	25	18.5	61	20	15	62	2320 (680)	165 (280)
ACS880-01-087A-2	R5	83	30	22	72	25	18.5	62	2491 (730)	165 (280)
ACS880-01-115A-2	R6	109	40	30	87	30	22	67	2866 (840)	256 (435)
ACS880-01-145A-2	R6	138	50	37	105	40	30	67	3207 (940)	256 (435)
ACS880-01-170A-2	R7	162	60	45	145	50	37	67	4299 (1260)	265 (450)
ACS880-01-206A-2	R7	196	75	55	169	60	45	67	5118 (1500)	265 (450)
ACS880-01-274A-2	R8 <sup>3)</sup>	260	100	75	213	70	55	65	7165 (2100)	324 (550)

$U_N = 500 \text{ V}$  (range 380 to 500 V). The power ratings are valid at nominal voltage 480 V.

Drive type	Frame size	Light-duty use			Heavy-duty use			Noise level	Heat dissipation	Air flow
		$I_{Ld}$ [A]	$P_{Ld}$ [HP]	$P_{Ld}$ [kW]	$I_{Hd}$ [A]	$P_{Hd}$ [HP]	$P_{Hd}$ [kW]			
ACS880-01-02A1-5	R1	2.1	1	0.75	1.7	0.75	0.55	46	102(30)	26(44)
ACS880-01-03A0-5	R1	3	1.5	1.1	2.1	1	0.75	46	136(40)	26(44)
ACS880-01-03A4-5	R1	3.4	2	1.5	3	1.5	1.1	46	177(52)	26(44)
ACS880-01-04A8-5	R1	4.8	3	2.2	3.4	2	1.5	46	249(73)	26(44)
ACS880-01-07A6-5	R1	7.6	5	4	5.2	3	3	46	416(122)	26(44)
ACS880-01-11A0-5	R1	11	7.5	5.5	7.6	5	4	46	587(172)	26(44)
ACS880-01-014A-5	R2	14	10	7.5	11	7.5	5.5	51	792(232)	52(88)
ACS880-01-021A-5	R2	21	15	11	14	10	7.5	51	1150(337)	52(88)
ACS880-01-027A-5	R3	27	20	15	21	15	11	57	1559(457)	79(134)
ACS880-01-034A-5	R3	34	25	18.5	27	20	15	57	1918(562)	79(134)
ACS880-01-040A-5	R4	40	30	22	34	25	18.5	62	2276(667)	79(134)
ACS880-01-052A-5	R4	52	40	30	40	30	22	62	3095(907)	165(280)
ACS880-01-065A-5	R5	65	50	37	52	40	30	62	3811(1117)	165(280)
ACS880-01-077A-5	R5	77	60	45	65	50	37	62	3822(1120)	165(280)
ACS880-01-096A-5	R6	96	75	55	77	60	45	67	4419(1295)	256(435)
ACS880-01-124A-5	R6	124	100	75	96	75	55	67	4913(1440)	256(435)
ACS880-01-156A-5	R7	156	125	90	124	100	75	67	6620(1940)	265(450)
ACS880-01-180A-5	R7	180	150	110	156	125	90	67	7882(2310)	265(450)
ACS880-01-240A-5	R8 <sup>4)</sup>	240	200	132	180	150	110	65	11260(3300)	324(550)
ACS880-01-260A-5	R8 <sup>3)</sup>	260	200	132	240 <sup>1)</sup>	150	110	65	13307(3900)	324(550)
ACS880-01-302A-5	R9 <sup>6)</sup>	302	250	187.5	260	200	132	68	16378(4800)	677(1150)
ACS880-01-361A-5	R9 <sup>6)</sup>	361	300	200	302	250	187.5	68	16378(4800)	677(1150)
ACS880-01-414A-5	R9 <sup>5)</sup>	414	350	250	361 <sup>2)</sup>	300	200	68	20473(6000)	677(1150)

<sup>3)</sup> For drives with enclosure class UL (NEMA) Type 12 / IP55 the ratings apply to 40 °C ambient temperature.

At higher temperature the derating is from 40 to 45 °C 1%/1 °C and 45 to 55 °C 2.5%/1 °C.

<sup>4)</sup> For drives with enclosure class UL (NEMA) Type 12 / IP55 the ratings apply to 40 °C ambient temperature.

At higher temperature the derating is from 40 to 50 °C 1%/1 °C and 50 to 55 °C 2.5%/1 °C.

<sup>5)</sup> For drives with enclosure class UL (NEMA) Type 12 / IP55 the maximum ambient temperature is 35 °C

<sup>6)</sup> For drives with enclosure class UL (NEMA) Type 12 / IP55 the ratings apply to 40 °C ambient temperature.

At higher temperatures the derating is from 40 to 45 °C.

1%/1 °C and 45 to 50 °C 2.5%/1 °C and 50 to 55 °C 5%/1 °C.

# Ratings, types and voltages

## ACS880-01+P940/P944

$U_N = 690 \text{ V}$  (range 525 to 690 V). The power ratings are valid at nominal voltage 575 V (kW rated at 690 V).

Drive type	Frame size	Light duty use			Heavy duty use			Noise level [db(A)]	Heat dissipation [BTU(W)]	Air flow [cfm(m <sup>3</sup> /h)]
		$I_{Ld}$ [A]	$P_{Ld}$ [HP]	$P_{Ld}$ [kW]	$I_{Hd}$ [A]	$P_{Hd}$ [HP]	$P_{Hd}$ [kW]			
ACS880-01-07A4-7	R3	7	5	5.5	5.6	3	4	57	389(114)	79(134)
ACS880-01-09A9-7	R3	9.4	7.5	7.5	7.4	5	5.5	57	488(143)	79(134)
ACS880-01-14A3-7	R3	13.6	10	11	9.9	7.5	7.5	57	706(207)	79(134)
ACS880-01-019A-7	R3	18	15	15	14.3	10	11	57	935(274)	79(134)
ACS880-01-023A-7	R3	22	20	18.5	19	15	15	57	1123(329)	79(134)
ACS880-01-027A-7	R3	27	25	22	23	20	18.5	57	1382(405)	79(134)
ACS880-01-035A-7	R5	33	40	30	26	30	22	62	2948(864)	165(280)
ACS880-01-042A-7	R5	40	50	37	35	40	30	62	3405(998)	165(280)
ACS880-01-049A-7	R5	47	50	45	42	40	37	62	3822(1120)	165(280)
ACS880-01-061A-7	R6	58	60	55	49	50	45	67	4419(1295)	256(435)
ACS880-01-084A-7	R6	80	75	75	61	60	55	67	4913(1440)	256(435)
ACS880-01-098A-7	R7	93	100	90	84	75	75	67	6620(1940)	265(450)
ACS880-01-119A-7	R7	113	125	110	98	100	90	67	7882(2310)	265(450)
ACS880-01-142A-7	R8	135	150	132	119	125	110	65	11260(3300)	324(550)
ACS880-01-174A-7	R8 <sup>3)</sup>	165	200	160	142	150	132	65	13307(3900)	324(550)
ACS880-01-210A-7	R9 <sup>7)</sup>	200	250	200	174	200	160	68	14331(4200)	677(1150)
ACS880-01-271A-7	R9 <sup>5)</sup>	257	250	250	210	250	200	68	16378(4800)	677(1150)

\*This unit is capable of delivering 192 amps continuous to 40 °C with no overload.

### Light-duty use

$I_{Ld}$  Continuous current allowing 110%  $I_{Ld}$  for 1 minute every 5 minutes to 40 °C.

$P_{Ld}$  Typical motor power in light-overload use.

### Heavy-duty use

$I_{Hd}$  Continuous current allowing 150%  $I_{Hd}$  for 1 minute every 5 minutes to 40 °C.

$P_{Hd}$  Typical motor power in heavy-duty use.

The ratings apply to 40 °C ambient temperature. At higher temperatures (up to 55 °C) the derating is 1%/1 °C.

<sup>3)</sup> For drives with enclosure class UL (NEMA) Type 12 / IP55 the ratings apply to 40 °C ambient temperature .  
At higher temperature the derating is from 40 to 45 °C 1%/1 °C and 45 to 55 °C 2.5%/1 °C.

<sup>5)</sup> For drives with enclosure class UL (NEMA) Type 12 / IP55 the maximum ambient temperature is 35 °C

<sup>7)</sup> For drives with UL (NEMA) Type 12 / IP55 enclosure class the ratings apply to 40 °C ambient temperature.

At higher temperatures the derating is from 40 to 45 °C 3.5%/1 °C.

Note: Maximum ambient temperature is 45 °C.





# Single drive modules

## ACS880-04/04F and ACS880-04XT/04FXT



01 ACS880-04 standard single drive module

02 ACS880-04 flat (sideways) mounting single drive module variant

03 ACS880-04XT high power single drive unit with parallel connected modules

04 ACS880-04F flange mounted single drive module

05 ACS880-04FXT flange mounted high power single drive unit with parallel connected modules

### Flexibility and ease of cabinet assembly

The ACS880 modules have all the essential features built-in. These standard and optional features include a choke for harmonic filtering, brake chopper, EMC filter, communication protocol adapter, functional safety and I/O extension modules. The built-in design combined with UL (NEMA) Type Open / IP20 protection significantly simplifies engineering.

The drive's compact size, flexible cabling options and versatile mounting possibilities from narrow side-by-side to flat mounting to horizontal mounting make it an ideal fit for almost any enclosure. The control unit with I/O and communication connections is mounted outside the power module.

The flange mounting variant (-04F/04FXT) with UL (NEMA) Type 12 / IP55 heat sink makes the drive suitable for harsh environments. High power units with parallel connected drive modules extends the power range with -04XT up to 1250 HP (1200 kW) and with -04FXT up to 2500 HP (2400 kW).

The drives have an extensive selection of built-in features and options. See page 87.

### Highlights

- UL (NEMA) Type Open / IP20 enclosure class
- Compact package with all the essential features built-in
- Wheels for easy maneuvering (-04/04XT)
- Flexible mounting and cabling directions
- Optimal drive layout
- Flange (push through) mounting (-04F/04FXT)

### Single drive modules,

#### ACS880-04/04F/04XT/04FXT

- Power ratings: 275 to 2500 HP (200 to 2400 kW)
- Enclosure classes: -04: UL (NEMA) Type Open / IP20, -04F: UL (NEMA) Type Open / IP20 [UL (NEMA) Type 12 / IP55 for heat sink side], -04XT: UL (NEMA) Type Open / IP00(IP20 with optional shrouds), -04FXT: UL (NEMA) Type Open / IP00 (IP20 with optional shrouds) [UL (NEMA) Type 12 / IP55 for heat sink side].

#### Main options:

- C2 and C3 EMC filters, see page 69
- Flat (sideways) mounting (-04/04XT)
- Various cabling related options, see page 80
- Brake chopper and resistor, see page 72
- Marine type approvals (-04/04XT)
- I/O extension modules, see page 63
- Communication protocol adapters, see page 63
- Application specific software, see page 16
- Speed feedback interfaces, see page 64
- Remote monitoring options, see page 65
- Functional safety modules, see page 67
- Du/dt filters, see page 77
- Sine filters, see page 71

- Tools and documents to support engineering (e.g. installation videos, EPLAN macros, accessories selection tool)
- Possibility for 6- or 12-pulse configurations (-04XT) 6-, 12-, 18- or 24-pulse configurations (-04FXT)

# High power single drive module packages ACS880-04



01



02

01 ACS880 high power drive module package with D8T+2×R8i

02 ACS880 R8i module which is used in ACS880-04 module packages

## Ready-made packages for easy installation

The ACS880-04 high power single drive module package includes a supply unit and a separate inverter unit. The supply unit consists of D7T or D8T half-controlled diode modules with thyristor charging. Parallel connected R8i modules are utilized in the inverter unit. The drive module packages are ready-sized and are available as 6-pulse or 12-pulse variants.

Installing and transporting the modules is easy, as they are equipped with wheels. Connecting the modules to the motor cables inside the cabinet is fast with the quick connectors. The modules can also be easily pulled out from a cabinet without any need for disconnecting the motor cables. The inverter module comes equipped with a removable fan pedestal, which makes motor cabling easy. To further shorten the engineering and assembly time several mechanical and electrical accessories are available.

## High power single drive module packages, ACS880-04

- Power ratings: 600 to 2250 HP (400 to 2200 kW)
- Enclosure classes: UL (NEMA) Type Open / IP00
- Built-in choke as standard for input harmonic reduction
- External control unit
- Speed controlled cooling fans
- Large power terminals allowing the use of a wide range of cable sizes
- Internal du/dt filters as standard in R8i inverter modules

### Main options:

- EMC filters, see page 69
- Brake chopper and resistor, see page 72
- Internal module heaters
- Direct-on-line, DOL, cooling fans

The drives have an extensive selection of built-in features and options. See See page 87.

## Highlights

- Optimized design for easy cabinet assembly (comes with wheels and quick connectors for motor cables)
- Wide selection of installation accessories
- Compact and modular design
- Complete cabinet design for Rittal VX25 cabinet
- Tools and documents to support engineering (e.g. installation videos, EPLAN macros, accessories selection tool, 3D models)
- Simple selection and ordering with single drive module packages

# Ratings, types and voltages

## ACS880-04, -04F, -04XT, -04FXT

$U_N = 500 \text{ V}$  (range 380 to 500 V). The power ratings are valid at nominal voltage 480 V.

Drive type	Frame size	Light duty use			Heavy duty use			Noise level	Heat dissipation	Air flow
		$I_{Ld}$ [A]	$P_{Ld}$ [HP]	$P_L d$ [kW]	$I_{Hd}$ [A]	$P_{Hd}$ [HP]	$P_{Hd}$ [kW]			
<b>ACS880-04, 6-pulse</b>										
ACS880-04-460A-5	R10	450	375	315	330	275	200	72	15024(4403)	706(1200)
ACS880-04-503A-5	R10	483	400	315	361	300	250	72	19115(5602)	706(1200)
ACS880-04-583A-5	R10	573	450	400	414	350	250	72	21868(6409)	706(1200)
ACS880-04-635A-5	R10	623	500	450	477	400	315	72	27713(8122)	706(1200)
ACS880-04-715A-5	R11	705	600	500	566	450	400	72	29904(8764)	706(1200)
ACS880-04-820A-5	R11	807	700	560	625	500	450	71	33651(9862)	836(1420)
ACS880-04-880A-5	R11	857	700	560	697 <sup>1)</sup>	600	500	71	37800(11078)	836(1420)
<b>ACS880-04F</b>										
ACS880-04F-459A-5	R11	450	375	315	330	275	200	75	15184(4450)	895(1520)
ACS880-04F-502A-5	R11	483	400	315	361	300	250	75	19279(5650)	895(1520)
ACS880-04F-582A-5	R11	573	450	400	414	350	250	75	22008(6450)	895(1520)
ACS880-04F-634A-5	R11	623	500	450	477	400	315	75	27809(8150)	895(1520)
ACS880-04F-715A-5	R11	705	600	500	566	450	400	75	30027(8800)	895(1520)
ACS880-04F-820A-5	R11	807	700	560	625	500	450	75	33780(9900)	895(1520)
ACS880-04F-880A-5	R11	857	700	560	697 <sup>1)</sup>	600	500	75	37875(11100)	895(1520)
<b>ACS880-04XT, 6- or 12-pulse</b>										
ACS880-04XT-1010A-5	2xR10	997	900	710	720	600	500	75	43737(12818)	1413(2400)
ACS880-04XT-1160A-5	2xR10	1146	1000	800	878	700	630	75	55427(16244)	1413(2400)
ACS880-04XT-1310A-5	2xR11	1297	1000	900	1041	900	710	75	59808(17528)	1413(2400)
ACS880-04XT-1610A-5	2xR11	1570	1250	1000	1282 <sup>1)</sup>	1000	900	74	72187(21156)	1672(2840)
<b>ACS880-04FXT, 6- or 12-pulse</b>										
ACS880-04FXT-1008A-5	2xR11	997	900	710	720	600	500	78	44017(12900)	1789(3040)
ACS880-04FXT-1158A-5	2xR11	1146	1000	800	878	700	630	78	55618(16300)	1789(3040)
ACS880-04FXT-1310A-5	2xR11	1297	1000	900	1041	900	710	78	60054(17600)	1789(3040)
ACS880-04FXT-1610A-5	2xR11	1570	1250	1000	1282 <sup>1)</sup>	1000	900	78	75750(22200)	1789(3040)

<sup>1)</sup> Continuous rms output current allowing 45% overload for 1 minute every 5 minutes

$U_N = 690 \text{ V}$  (range 525 to 690 V). The power ratings are valid at nominal voltage 575 V (kW rated at 690 V).

Drive type	Frame size	Light duty use			Heavy duty use			Noise level	Heat dissipation	Air flow
		$I_{Ld}$ [A]	$P_{Ld}$ [HP]	$P_{Ld}$ [kW]	$I_{Hd}$ [A]	$P_{Hd}$ [HP]	$P_{Hd}$ [kW]			
<b>ACS880-04, 6-pulse</b>										
ACS880-04-330A-7	R10	320	300	315	255	250	250	72	15024(4403)	706(1200)
ACS880-04-370A-7	R10	360	350	355	325	300	315	72	19115(5602)	706(1200)
ACS880-04-430A-7	R10	420	450	450	360 <sup>2)</sup>	350	350	72	21868(6409)	706(1200)
ACS880-04-470A-7	R11	455	450	450	415	450	400	72	27713(8122)	706(1200)
ACS880-04-522A-7	R11	505	500	500	455	450	450	72	29904(8764)	706(1200)
ACS880-04-590A-7	R11	571	600	560	505	500	500	71	33651(9862)	706(1200)
ACS880-04-650A-7	R11	630	700	630	571 <sup>2)</sup>	600	560	71	36094(10578)	836(1420)
ACS880-04-721A-7	R11	705	700	630	571 <sup>2)</sup>	600	560	71	36094(10578)	836(1420)
<b>ACS880-04F</b>										
ACS880-04F-329A-7	R11	320	300	315	255	250	250	75	15184(4450)	895(1520)
ACS880-04F-369A-7	R11	360	350	355	325	300	315	75	19279(5650)	895(1520)
ACS880-04F-429A-7	R11	420	450	400	360 <sup>2)</sup>	350	355	75	22008(6450)	895(1520)
ACS880-04F-470A-7	R11	455	450	450	415	450	400	75	27809(8150)	895(1520)
ACS880-04F-522A-7	R11	505	500	500	455	450	450	75	30027(8800)	895(1520)
ACS880-04F-590A-7	R11	571	600	560	505	500	500	75	33780(9900)	895(1520)
ACS880-04F-650A-7	R11	630	700	630	571 <sup>2)</sup>	600	560	75	37875(11100)	895(1520)
ACS880-04F-721A-7	R11	705	700	630	571 <sup>2)</sup>	600	560	75	37875(11100)	895(1520)
<b>ACS880-04XT, 6- or 12-pulse</b>										
ACS880-04XT-0810A-7	2xR10	791	800	710	678 <sup>2)</sup>	700	630	75	43737(12818)	1413(2400)
ACS880-04XT-0960A-7	2xR11	929	1000	900	837	800	800	75	59808(17528)	1413(2400)
ACS880-04XT-1080A-7	2xR11	1051	1000	1000	929	1000	900	75	67301(19724)	1413(2400)
ACS880-04XT-1320A-7	2xR11	1297	1250	1200	1051 <sup>2)</sup>	1000	1000	74	72187(21156)	1672(2840)
<b>ACS880-04FXT, 6- or 12-pulse</b>										
ACS880-04FXT-0808A-7	2xR11	791	800	710	678 <sup>2)</sup>	700	630	78	44017(12900)	1789(3040)
ACS880-04FXT-0960A-7	2xR11	929	1000	900	837	800	800	78	60054(17600)	1789(3040)
ACS880-04FXT-1080A-7	2xR11	1051	1000	1000	929	1000	900	78	67560(19800)	1789(3040)
ACS880-04FXT-1320A-7	2xR11	1297	1250	1200	1051 <sup>2)</sup>	1000	1000	78	75750(22200)	1789(3040)

<sup>2)</sup> Continuous rms output current allowing 45% overload for 1 minute every 5 minutes

#### Light-duty use

$I_{Ld}$  Continuous current allowing 110%  $I_{Ld}$  for 1 minute every 5 minutes to 40 °C.

$P_{Ld}$  Typical motor power in light-overload use.

#### Heavy-duty use

$I_{Hd}$  Continuous current allowing 150%  $I_{Hd}$  for 1 minute every 5 minutes to 40 °C.

$P_{Hd}$  Typical motor power in heavy-duty use.

The ratings apply to 40 °C ambient temperature. At higher temperatures (up to 50 °C <sup>4)</sup> or up to 55 °C <sup>5)</sup>) the derating is 1%/1 °C.

<sup>4)</sup> ACS880-04 high power single drive package.

<sup>5)</sup> ACS880-04 single drive module.

# Ratings, types and voltages

## ACS880-04 nxR8i

$U_N = 500 \text{ V}$  (range 380 to 500 V). The power ratings are valid at nominal voltage 480 V.

Drive type	Frame size	Light duty use			Heavy duty use			Noise level [db(A)]	Heat dissipation [BTU(W)]	Air flow [cfm(m <sup>3</sup> /h)]
		$I_{Ld}$ [A]	$P_{Ld}$ [HP]	$P_{Ld}$ [kW]	$I_{Hd}$ [A]	$P_{Hd}$ [HP]	$P_{Hd}$ [kW]			
<b>6-pulse</b>										
ACS880-04-1070A-5	D8T+2xR8i	1027	900	710	800	700	560	73	61419(18000)	2525(4290)
ACS880-04-1320A-5	2xD8T+2xR8i	1267	1000	900	987	800	710	74	75067(22000)	3367(5720)
ACS880-04-1450A-5	2xD8T+2xR8i	1392	1250	900	1085	900	710	74	85304(25000)	3367(5720)
ACS880-04-1580A-5	2xD8T+2xR8i	1517	1250	1000	1182	1000	800	74	92128(27000)	3367(5720)
ACS880-04-1800A-5	2xD8T+3xR8i	1728	1500	1200	1346	1000	900	75	109189(32000)	4208(7150)
ACS880-04-1980A-5	2xD8T+3xR8i	1901	1500	1300	1481	1250	1000	75	122837(36000)	4208(7150)
<b>6- or 12-pulse</b>										
ACS880-04-0990A-5+A004	2xD7T+2xR8i	950	800	630	741	600	500	73	54594(16000)	3367(5720)
ACS880-04-1320A-5+A004	2xD8T+2xR8i	1267	1000	900	987	800	710	74	75067(22000)	3367(5720)
ACS880-04-1450A-5+A004	2xD8T+2xR8i	1392	1250	900	1085	900	710	74	85304(25000)	3367(5720)
ACS880-04-1580A-5+A004	2xD8T+2xR8i	1517	1250	1000	1182	1000	800	74	92128(27000)	3367(5720)
ACS880-04-1800A-5+A004	2xD8T+3xR8i	1728	1500	1200	1346	1000	900	75	109189(32000)	4208(7150)
ACS880-04-1980A-5+A004	2xD8T+3xR8i	1901	1500	1300	1481	1250	1000	75	122837(36000)	4208(7150)

$U_N = 690 \text{ V}$  (range 525 to 690 V). The power ratings are valid at nominal voltage 575 V (kW rated at 690 V).

Drive type	Frame size	Light duty use			Heavy duty use			Noise level [db(A)]	Heat dissipation [BTU(W)]	Air flow [cfm(m <sup>3</sup> /h)]
		$I_{Ld}$ [A]	$P_{Ld}$ [HP]	$P_{Ld}$ [kW]	$I_{Hd}$ [A]	$P_{Hd}$ [HP]	$P_{Hd}$ [kW]			
<b>6-pulse</b>										
ACS880-04-0800A-7	D8T+2xR8i	768	800	710	598	600	560	73	54594(16000)	2525(4290)
ACS880-04-0900A-7	D8T+2xR8i	864	900	800	673	600	630	74	68243(20000)	2525(4290)
ACS880-04-1160A-7	2xD8T+2xR8i	1114	1000	1100	868	900	800	74	88716(26000)	3367(5720)
ACS880-04-1450A-7	2xD8T+3xR8i	1392	1500	1250	1085	1000	1000	75	109189(32000)	4208(7150)
ACS880-04-1650A-7	2xD8T+3xR8i	1584	1500	1500	1234	1250	1200	75	124543(36500)	4208(7150)
ACS880-04-2300A-7	3xD8T+4xR8i	2208	2250	2000	1720	1750	1600	76	177431(52000)	5892(10010)
<b>6- or 12-pulse</b>										
ACS880-04-0800A-7+A004	2xD7T+2xR8i	768	800	710	598	600	560	73	54594(16000)	3367(5720)
ACS880-04-0950A-7+A004	2xD8T+2xR8i	912	900	800	711	700	630	74	68243(20000)	3367(5720)
ACS880-04-1160A-7+A004	2xD8T+2xR8i	1114	1000	1100	868	900	800	74	88716(26000)	3367(5720)
ACS880-04-1450A-7+A004	2xD8T+3xR8i	1392	1500	1250	1085	1000	1000	75	109189(32000)	4208(7150)
ACS880-04-1650A-7+A004	2xD8T+3xR8i	1584	1500	1500	1234	1250	1200	75	124543(36500)	4208(7150)
ACS880-04-2300A-7+A004	4xD8T+4xR8i	2208	2250	2000	1720	1750	1600	77	177431(52000)	6733(11440)

### Light-duty use

$I_{Ld}$  Continuous current allowing 110%  $I_{Ld}$  for 1 minute every 5 minutes to 40 °C.

$P_{Ld}$  Typical motor power in light-overload use.

### Heavy-duty use

$I_{Hd}$  Continuous current allowing 150%  $I_{Hd}$  for 1 minute every 5 minutes to 40 °C.

$P_{Hd}$  Typical motor power in heavy-duty use.

The ratings apply to 40 °C ambient temperature. At higher temperatures (up to 50 °C or up to 55 °C) the derating is 1%/1 °C.



# Regenerative drive modules

## ACS880-11+P940 and ACS880-14

—  
01 Speed and power  
curves in cyclic operation

ABB regenerative drive modules are optimized for cabinet assembly. ACS880-11+P940 and ACS880-14 frame R11 are compact and complete drive solutions, with everything needed for regenerative operation in cyclic or continuous braking applications. For high power applications ACS880-14 single drive module packages are available.

### Energy savings

With regenerative functionality, the braking energy of the motor is returned to the drive and distributed to the supply network so that it can be utilized by other equipment. Compared to mechanical or resistor braking, where braking energy is wasted as heat, regenerative drive operation offers significant savings in energy consumption and cooling.

The drive reaches unity power factor. This high power factor indicates that electrical energy is used to its full potential.

### Minimized downtime

Regenerative drives offer immunity to network disturbances. The drive will not interrupt the process or affect process quality in unstable supply network conditions. The ACS880 drive's active supply unit is able to boost output voltage, resulting in full motor voltage even when the supply voltage is below nominal. Voltage boost capability can also be utilized to overcome a voltage drop caused by long supply or motor cables or output filters.

### Optimized cost and space

Everything needed for regenerative operation, such as an active supply unit and low harmonic line filter are included, and no external braking devices are needed.

Advantages:

- Quick, easy drive installation
- Small installation footprint
- No need to add cooling to handle the heat generated by mechanical or resistor braking
- Simplified wiring
- Less spare parts needed

The “all inside” design for frames up to R11 and mechanical installation kits for module packages help to cut engineering and assembly time, as well as to reduce equipment costs and the risk of errors.

The drive's voltage boost capability can be an advantage in motor sizing. With a higher motor voltage, the same power is achieved with less current, which may allow a smaller motor to be used.

With the ACS880 regenerative drive it is possible to compensate for low power factors of equipment connected to the same network. This reduces the need for additional power factor correction equipment, including filters and large capacitor banks. It can also help avoid penalty charges from electrical utilities for poor power factor.

### Maximized motor performance and efficiency

The drive is able to provide full motor voltage in all conditions. ACS880 drives can regenerate 100% current to the line continuously.

The drive features Direct Torque Control (DTC) as standard, making it suitable for very demanding applications. DTC provides precise speed and torque control for maximum motor performance and efficiency.

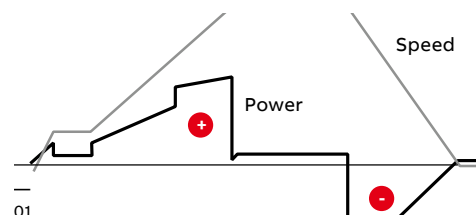

### Low harmonic content

The drive produces exceptionally low harmonic content and exceeds the requirements of even the most stringent harmonic specifications including IEEE 519, IEC 61000-3-2, IEC 61000-3-12 and G5/4. The total harmonic current distortion is typically <3% in nominal situations and with undistorted networks, whereas conventional drives typically have 35% harmonic current distortion.

For more information, visit <https://new.abb.com/drives/regenerativedrives>.

—  
01 ACS880-11+P940

—  
02 ACS880-14  
frame size R11

—  
03 ACS880-14 drive  
module package, BLCL  
line filter and R8i modules



**Regenerative single drive modules,  
ACS880-11+P940 and ACS880-14 frame R11**

- Power ratings: 3 to 450 HP (2.2 to 400 kW)
- Enclosure classes: UL (NEMA) Type Open / IP20, in flange mounting (ACS880-11) heat sink side UL (NEMA) Type 12 / IP55

Main options:

- Flange mounting (only ACS880-11)
- C2 and C3 EMC filters, see page 69
- I/O extension modules, see page 63
- Communication protocol adapters, see page 63
- Speed feedback interfaces, see page 64
- Functional safety modules, see page 67
- Remote monitoring options, see page 65
- Application specific software, see page 16
- Du/dt filters, see page 77
- Sine filters, see page 71

**Regenerative single drive module package,  
ACS880-14, BLCL line filter and R8i frames**

- Power ratings: 250 to 2250 HP (160 to 2200 kW)
- Enclosure class: UL (NEMA) Type Open / IP00
- External control unit
- Speed controlled cooling fans in R8i modules. Direct-on-line fans in BLCL filters.
- Internal du/dt filters in R8i modules

Main options:

- C2 EMC filters, see page 69
- I/O extension modules, see page 63
- Communication protocol adapters, see page 63
- Speed feedback interfaces, see page 64
- Functional safety modules, see page 67
- Remote monitoring options, see page 65
- Application specific software, see page 16
- Internal heaters in R8i and BLCL modules
- Direct-on-line cooling fans

The drives have an extensive selection of built-in features and options. See page 87.

**Highlights**

- Everything for regenerative operation in one compact UL (NEMA) Open Type / IP20 package up to 450 HP (355 kW) frame R11
- Can regenerate 100% of the power continuously
- The total harmonic current distortion is typically <3% in nominal situations and undistorted networks
- Clear energy savings compared to other braking methods
- Unity power factor. Can often compensate for poor network power factor correction
- Stable output voltage in all load conditions, even with fluctuating supply voltage
- Mechanical installation kits for easy engineering and assembly of module packages
- Optional flange (push through) mounting up to frame R11

# Ratings, types and voltages

## Wall-mounted regenerative drive modules, ACS880-11

$U_N = 500 \text{ V}$  (range 380 to 500 V). The power ratings are valid at nominal voltage 480 V.

Drive type	Frame size	Light duty use			Heavy duty use			Noise level	Heat dissipation	Air flow
		$I_{Ld}$ [A]	$P_{Ld}$ [HP]	$P_{Ld}$ [kW]	$I_{Hd}$ [A]	$P_{Hd}$ [HP]	$P_{Hd}$ [kW]			
ACS880-11-07A6-5	R3	7.6	5	4	5.2	3	2.2	57	747(219)	212(361)
ACS880-11-11A0-5	R3	11	7.5	5.5	7.6	5	4	57	949(278)	212(361)
ACS880-11-014A-5	R3	14	10	7.5	11	7.5	5.5	57	1095(321)	212(361)
ACS880-11-021A-5	R3	21	15	11	14	10	7.5	57	1614(473)	212(361)
ACS880-11-027A-5	R6	27	20	15	21	15	11	71	2133(625)	324(550)
ACS880-11-034A-5	R6	34	25	18.5	27	20	15	71	2426(711)	324(550)
ACS880-11-040A-5	R6	40	30	22	34	25	18.5	71	2754(807)	324(550)
ACS880-11-052A-5	R6	52	40	30	40	30	22	71	3276(960)	324(550)
ACS880-11-065A-5	R6	65	50	37	52	40	30	71	4173(1223)	324(550)
ACS880-11-077A-5	R6	77	60	45	65	50	37	71	5323(1560)	324(550)
ACS880-11-101A-5	R8	96	75	55	77	60	45	68	6807(1995)	412(700)
ACS880-11-124A-5	R8	124	100	75	96	75	55	68	9554(2800)	412(700)
ACS880-11-156A-5	R8	156	125	90	124	100	75	68	10810(3168)	412(700)
ACS880-11-180A-5	R8	180	150	110	156	125	90	68	13212(3872)	474(805)

### Light-duty use

$I_{Ld}$  Continuous current allowing 110%  $I_{Ld}$  for 1 minute every 5 minutes to 40 °C.

$P_{Ld}$  Typical motor power in light-overload use.

### Heavy-duty use

$I_{Hd}$  Continuous current allowing 150%  $I_{Hd}$  for 1 minute every 5 minutes to 40 °C.

$P_{Hd}$  Typical motor power in heavy-duty use.

The ratings apply to 40 °C ambient temperature.

At higher temperatures (up to 55 °C) the derating is 1%/1 °C.

# Ratings, types and voltages

## Regenerative drive modules, ACS880-14 frame R11

$U_N = 500 \text{ V}$  (range 380 to 500 V). The power ratings are valid at nominal voltage 480 V.

Drive type	Frame size	Light duty use			Heavy duty use			Noise level	Heat dissipation	Air flow
		$I_{Ld}$ [A]	$P_{Ld}$ [HP]	$P_{Ld}$ [kW]	$I_{Hd}$ [A]	$P_{Hd}$ [HP]	$P_{Hd}$ [kW]			
ACS880-14-240A-5	R11	240	200	132	180	150	110	75	18016(5280)	1236(2100)
ACS880-14-260A-5	R11	260	200	132	240	200	132	75	21838(6400)	1236(2100)
ACS880-14-302A-5	R11	302	250	200	260	200	132	75	27297(8000)	1236(2100)
ACS880-14-361A-5	R11	361	300	200	302	250	200	75	27297(8000)	1236(2100)
ACS880-14-414A-5	R11	414	350	250	361	300	200	75	34121(10000)	1236(2100)
ACS880-14-460A-5	R11	430	350	250	414	350	250	75	42993(12600)	1236(2100)
ACS880-14-503A-5	R11	483	400	315	483	400	250	75	48452(14200)	1236(2100)

$U_N = 690 \text{ V}$  (range 525 to 690 V). The power ratings are valid at nominal voltage 575 V (kW rated at 690 V).

Drive type	Frame size	Light duty use			Heavy duty use			Noise level	Heat dissipation	Air flow
		$I_{Ld}$ [A]	$P_{Ld}$ [HP]	$P_{Ld}$ [kW]	$I_{Hd}$ [A]	$P_{Hd}$ [HP]	$P_{Hd}$ [kW]			
ACS880-14-142A-7	R11	144	150	110	125	125	90	75	18016(5280)	1236(2100)
ACS880-14-174A-7	R11	168	150	110	144	150	110	75	21838(6400)	1236(2100)
ACS880-14-210A-7	R11	192	200	132	168	150	110	75	27297(8000)	1236(2100)
ACS880-14-271A-7	R11	242	250	200	192	200	132	75	34121(10000)	1236(2100)
ACS880-14-330A-7	R11	289	300	200	242	250	200	75	42993(12600)	1236(2100)
ACS880-14-370A-7	R11	336	350	250	289	300	200	75	48452(14200)	1236(2100)
ACS880-14-430A-7	R11	412	450	315	336	350	250	75	54594(16000)	1236(2100)

### Light-duty use

$I_{Ld}$  Continuous current allowing 110%  $I_{Ld}$  for 1 minute every 5 minutes to 40 °C.

$P_{Ld}$  Typical motor power in light-overload use.

### Heavy-duty use

$I_{Hd}$  Continuous current allowing 150%  $I_{Hd}$  for 1 minute every 5 minutes to 40 °C.

$P_{Hd}$  Typical motor power in heavy-duty use.

The ratings apply to 40 °C ambient temperature.

At higher temperatures (up to 55 °C) the derating is 1%/1 °C.

# Ratings, types and voltages

## Regenerative drive module packages, ACS880-14

$U_N = 500 \text{ V}$  (range 380 to 500 V). The power ratings are valid at nominal voltage 480 V.

Drive type	Frame size	Light duty use			Heavy duty use			Noise level	Heat dissipation	Air flow
		$I_{Ld}$ [A]	$P_{Ld}$ [HP]	$P_{Ld}$ [kW]	$I_{Hd}$ [A]	$P_{Hd}$ [HP]	$P_{Hd}$ [kW]			
ACS880-14-0420A-5	R8i + BLCL-13-5 + R8i	403	300	250	314	250	200	75	44358(13)	2213(3760)
ACS880-14-0570A-5	R8i + BLCL-13-5 + R8i	547	450	355	426	350	250	75	58006(17)	2213(3760)
ACS880-14-0780A-5	R8i + BLCL-15-5 + R8i	749	600	500	583	500	400	75	85304(25)	2213(3760)
ACS880-14-1110A-5	2xR8i + BLCL-24-5 + 2xR8i	1066	900	710	830	700	560	77	109189(32)	4250(7220)
ACS880-14-1530A-5	2xR8i + BLCL-25-5 + 2xR8i	1469	1250	1000	1144	1000	800	77	156959(46)	4250(7220)
ACS880-14-1980A-5	3xR8i + 2xBLCL-24-5 + 3xR8i	1901	1500	1300	1481	1250	1000	78	201316(59)	6816(11580)
ACS880-14-2270A-5	3xR8i + 2xBLCL-24-5 + 3xR8i	2179	1900	1500	1698	1500	1200	78	235438(69)	6816(11580)

$U_N = 690 \text{ V}$  (range 525 to 690 V). The power ratings are valid at nominal voltage 575 V (kW rated at 690 V).

Drive type	Frame size	Light duty use			Heavy duty use			Noise level	Heat dissipation	Air flow
		$I_{Ld}$ [A]	$P_{Ld}$ [HP]	$P_{Ld}$ [kW]	$I_{Hd}$ [A]	$P_{Hd}$ [HP]	$P_{Hd}$ [kW]			
ACS880-14-0320A-7	R8i + BLCL-13-7 + R8i	307	300	250	239	250	200	75	54594(16)	2213(3760)
ACS880-14-0390A-7	R8i + BLCL-13-7 + R8i	374	350	355	292	300	250	75	64831(19)	2213(3760)
ACS880-14-0580A-7	R8i + BLCL-15-7 + R8i	557	600	500	434	450	400	75	88716(26)	2213(3760)
ACS880-14-0770A-7	2xR8i + BLCL-24-7 + 2xR8i	739	600	710	576	600	560	77	116013(34)	4250(7220)
ACS880-14-0950A-7	2xR8i + BLCL-25-7 + 2xR8i	912	700	800	711	700	710	77	136486(40)	4250(7220)
ACS880-14-1130A-7	2xR8i + BLCL-25-7 + 2xR8i	1085	1000	1000	845	1000	800	77	163783(48)	4250(7220)
ACS880-14-1450A-7	3xR8i + 2xBLCL-24-7 + 3xR8i	1392	1100	1300	1085	1100	1000	78	214965(63)	6816(11580)
ACS880-14-1680A-7	3xR8i + 2xBLCL-24-7 + 3xR8i	1613	1500	1500	1257	1250	1200	78	252499(74)	6816(11580)
ACS880-14-2230A-7	4xR8i + 2xBLCL-25-7 + 4xR8i	2141	2250	2000	1668	1750	1600	79	324153(95)	8499(14440)

### Light-duty use

$I_{Ld}$  Continuous current allowing 110%  $I_{Ld}$  for 1 minute every 5 minutes to 40 °C.

$P_{Ld}$  Typical motor power in light-overload use.

### Heavy-duty use

$I_{Hd}$  Continuous current allowing 150%  $I_{Hd}$  for 1 minute every 5 minutes to 40 °C.

$P_{Hd}$  Typical motor power in heavy-duty use.

The ratings apply to 40 °C ambient temperature.

At higher temperatures (up to 55 °C) the derating is 1%/1 °C.





# Ultra-low harmonic drive modules

## ACS880-31+P940 and ACS880-34

Harmonic distortions can disturb or even damage sensitive equipment connected in the same environment. Harmonics also cause additional losses in the network.

The ACS880-31+P940 and ACS880-34 frame R11 are compact, complete drive modules with harmonic mitigation built-in. For high power solutions, the ACS880-34 single drive module packages are available.

### Clean supply network

Our ultra-low harmonic drive produces exceptionally low harmonic content and exceeds the requirements of harmonic specifications including IEEE 519 and G5/4. Compared to a conventional drive, the harmonic content is reduced by up to 97%. The total harmonic current distortion is typically <3% in nominal situations with an undistorted network.

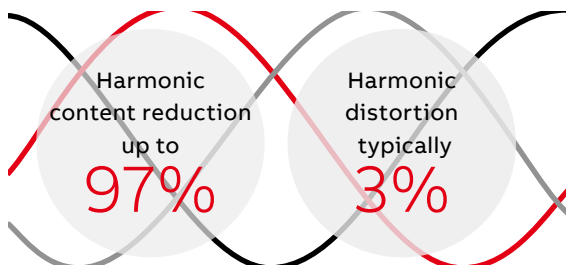

### Minimized downtime

ABB's ultra-low harmonic drive offers immunity to network disturbances. The drive will not interrupt the process or affect process quality in unstable supply network conditions. The ACS880 drive's active supply unit is able to boost the output voltage resulting in full motor voltage even when the supply voltage is below nominal. This ensures reliable operation in weak networks. This voltage boost capability can also be utilized to overcome voltage drops caused by long supply or motor cables.

### Optimized cost and space

The compact ACS880 low harmonic drive solution has harmonic mitigation built-in. This includes an active supply unit and low harmonic line filter. There is no need for external filters, multi-pulse arrangements or special transformers, resulting in significant savings in space, time and cost.

Oversizing cables, transformers and other distribution equipment due to harmonic current overheating can often be ignored when using the ACS880 low harmonic drive.

The drive's voltage boost capability can be an advantage in motor sizing. With a higher motor voltage, the same power is achieved with less current, which improves motor efficiency and may allow a smaller motor to be used.

### Maximized motor performance and efficiency

The drive is able to provide full motor voltage even if the supply voltage fluctuates. It features Direct Torque Control (DTC) as standard, making it suitable for very demanding applications. DTC provides precise speed and torque control for maximum motor performance and motor efficiency.

### Keeps the network clean

#### Efficient energy utilization

Ultra-low harmonic drives achieve unity power factor. This high power factor indicates that electrical energy is used efficiently.

The ACS880 offers the possibility to compensate for low power factors of equipment connected to the same network. This can help to avoid penalty charges set by electrical utilities for poor power factor.

Lower harmonics and full motor voltage at all times means reduced system losses and better overall system efficiency.

For more information, visit <https://new.abb.com/drives/harmonics>.

- 01 ACS880-31+P940
- 02 ACS880-34 frame size R11
- 03 ACS880-34 drive module package, BLCL line filter and R8i modules



#### Ultra-low harmonic single drive modules, ACS880-31+P940 and ACS880-34 frame R11

- Power ratings: 3 to 450 HP (2.2 to 400 kW)
- Enclosure classes: UL (NEMA) Type Open / IP20, in flange mounting (ACS880-31) heat sink side UL (NEMA) Type 12 / IP55

#### Main options:

- Flange mounting (Only ACS880-31)
- C2 and C3 EMC filters, see page 69
- I/O extension modules, see page 63
- Communication protocol adapters, see page 63
- Speed feedback interfaces, see page 64
- Functional safety modules, see page 67
- Remote monitoring options, see page 65
- Application specific software, see page 16
- Du/dt filters, see page 77
- Sine filters, see page 71

#### Ultra-low harmonic single drive module package, ACS880-34, BLCL line filter and R8i frames

- Power ratings: 250 to 2250 (200 to 2000 kW)
- Enclosure class: UL (NEMA) Type Open / IP00
- External control unit
- Speed controlled cooling fans in R8i modules. Direct-on-line fans in BLCL filters.
- Internal du/dt filters in R8i modules

#### Main options:

- C2 EMC filters, see page 69
- I/O extension modules, see page 63
- Communication protocol adapters, see page 63
- Speed feedback interfaces, see page 64
- Functional safety modules, see page 67
- Remote monitoring options, see page 65
- Application specific software, see page 16
- Internal heaters in R8i and BLCL modules
- Direct-on-line cooling fans

The drives have an extensive selection of built-in features and options. See page 87.

#### Highlights

- The total harmonic current distortion is typically <3% in nominal situations and undistorted networks.
- No need for external filters, multi-pulse arrangements or special transformers
- Simple and cost-effective installation
- Unity power factor. May correct power factor for some networks
- Stable output voltage in all load conditions, even with fluctuating supply voltage.
- Small installation footprint
- Mechanical installation kits for easy engineering and assembly of module packages
- Optional flange (push through) mounting up to frame R11.

# Ratings, types and voltages

## Wall-mounted ultra-low harmonic drives, ACS880-31

$U_N = 500$  V (range 380 to 500 V). The power ratings are valid at nominal voltage 480 V.

Drive type	Frame size	Light duty use			Heavy duty use			Noise level [db(A)]	Heat dissipation [BTU(W)]	Air flow [cfm(m <sup>3</sup> /h)]
		$I_{Ld}$ [A]	$P_{Ld}$ [HP]	$P_{Ld}$ [kW]	$I_{Hd}$ [A]	$P_{Hd}$ [HP]	$P_{Hd}$ [kW]			
ACS880-31-07A6-5	R3	7.6	5	4	5.2	3	2.2	57	747(219)	212(361)
ACS880-31-11A0-5	R3	11	7.5	5.5	7.6	5	4	57	949(278)	212(361)
ACS880-31-014A-5	R3	14	10	7.5	11	7.5	5.5	57	1095(321)	212(361)
ACS880-31-021A-5	R3	21	15	11	14	10	7.5	57	1614(473)	212(361)
ACS880-31-027A-5	R6	27	20	15	21	15	11	71	2133(625)	324(550)
ACS880-31-034A-5	R6	34	25	18.5	27	20	15	71	2426(711)	324(550)
ACS880-31-040A-5	R6	40	30	22	34	25	18.5	71	2754(807)	324(550)
ACS880-31-052A-5	R6	52	40	30	40	30	22	71	3276(960)	324(550)
ACS880-31-065A-5	R6	65	50	37	52	40	30	71	4173(1223)	324(550)
ACS880-31-077A-5	R6	77	60	45	65	50	37	71	5323(1560)	324(550)
ACS880-31-101A-5	R8	96	75	55	77	60	45	68	6807(1995)	412(700)
ACS880-31-124A-5	R8	124	100	75	96	75	55	68	9554(2800)	412(700)
ACS880-31-156A-5	R8	156	125	90	124	100	75	68	10810(3168)	412(700)
ACS880-31-180A-5	R8	180	150	110	156	125	90	68	13212(3872)	474(805)

### Light-duty use

$I_{Ld}$  Continuous current allowing 110%  $I_{Ld}$  for 1 minute every 5 minutes to 40 °C.

$P_{Ld}$  Typical motor power in light-overload use.

### Heavy-duty use

$I_{Hd}$  Continuous current allowing 150%  $I_{Hd}$  for 1 minute every 5 minutes to 40 °C.

$P_{Hd}$  Typical motor power in heavy-duty use.

The ratings apply to 40 °C ambient temperature.

At higher temperatures (up to 55 °C) the derating is 1%/1 °C.

# Ratings, types and voltages

## Ultra-low harmonic drive modules, ACS880-34 R11

$U_N = 500 \text{ V}$  (range 380 to 500 V). The power ratings are valid at nominal voltage 480 V.

Drive type	Frame size	Light duty use			Heavy duty use			Noise level	Heat dissipation	Air flow
		$I_{Ld}$ [A]	$P_{Ld}$ [HP]	$P_{Ld}$ [kW]	$I_{Hd}$ [A]	$P_{Hd}$ [HP]	$P_{Hd}$ [kW]			
ACS880-34-240A-5	R11	240	200	132	180	150	110	75	18016(5280)	1236(2100)
ACS880-34-260A-5	R11	260	200	160	240	200	132	75	21838(6400)	1236(2100)
ACS880-34-302A-5	R11	302	250	200	260	200	132	75	27297(8000)	1236(2100)
ACS880-34-361A-5	R11	361	300	200	302	250	160	75	27297(8000)	1236(2100)
ACS880-34-414A-5	R11	414	350	250	361	300	200	75	34121(10000)	1236(2100)
ACS880-34-460A-5	R11	430	350	315	414	350	250	75	42993(12600)	1236(2100)
ACS880-34-503A-5	R11	483	400	355	483	400	315	75	48452(14200)	1236(2100)

$U_N = 690 \text{ V}$  (range 525 to 690 V). The power ratings are valid at nominal voltage 575 V (kW rated at 690 V).

Drive type	Frame size	Light duty use			Heavy duty use			Noise level	Heat dissipation	Air flow
		$I_{Ld}$ [A]	$P_{Ld}$ [HP]	$P_{Ld}$ [kW]	$I_{Hd}$ [A]	$P_{Hd}$ [HP]	$P_{Hd}$ [kW]			
ACS880-34-142A-7	R11	144	150	110	125	125	90	75	18016(5280)	1236(2100)
ACS880-34-174A-7	R11	168	150	110	144	150	110	75	21838(6400)	1236(2100)
ACS880-34-210A-7	R11	192	200	132	168	150	110	75	27297(8000)	1236(2100)
ACS880-34-271A-7	R11	242	250	200	192	200	132	75	34121(10000)	1236(2100)
ACS880-34-330A-7	R11	289	300	200	242	250	200	75	42993(12600)	1236(2100)
ACS880-34-370A-7	R11	336	350	250	289	300	200	75	48452(14200)	1236(2100)
ACS880-34-430A-7	R11	412	450	315	336	350	250	75	54594(16000)	1236(2100)

### Light-duty use

$I_{Ld}$  Continuous current allowing 110%  $I_{Ld}$  for 1 minute every 5 minutes to 40 °C.

$P_{Ld}$  Typical motor power in light-overload use.

### Heavy-duty use

$I_{Hd}$  Continuous current allowing 150%  $I_{Hd}$  for 1 minute every 5 minutes to 40 °C.

$P_{Hd}$  Typical motor power in heavy-duty use.

The ratings apply to 40 °C ambient temperature.

At higher temperatures (up to 55 °C) the derating is 1%/1 °C.

# Ratings, types and voltages

## Ultra-low harmonic module packages

### ACS880-34

$U_N = 500$  V (range 380 to 500 V). The power ratings are valid at nominal voltage 480 V.

Drive type	Frame size	Light duty use			Heavy duty use			Noise level [db(A)]	Heat dissipation [BTU(kW)]	Air flow [cfm(m <sup>3</sup> /h)]
		$I_{Ld}$ [A]	$P_{Ld}$ [HP]	$P_{Ld}$ [kW]	$I_{Hd}$ [A]	$P_{Hd}$ [HP]	$P_{Hd}$ [kW]			
ACS880-34-0420A-5	R8i + BLCL-13-5 + R8i	403	300	250	314	250	200	75	44358(13)	2213(3760)
ACS880-34-0570A-5	R8i + BLCL-13-5 + R8i	547	450	355	426	350	250	75	58006(17)	2213(3760)
ACS880-34-0780A-5	R8i + BLCL-15-5 + R8i	749	600	500	583	500	400	75	85304(25)	2213(3760)
ACS880-34-1110A-5	2xR8i + BLCL-24-5 + 2xR8i	1066	900	710	830	700	560	77	109189(32)	4250(7220)
ACS880-34-1530A-5	2xR8i + BLCL-25-5 + 2xR8i	1469	1250	1000	1144	1000	800	77	156959(46)	4250(7220)
ACS880-34-1980A-5	3xR8i + 2xBLCL-24-5 + 3xR8i	1901	1500	1300	1481	1250	1000	78	201316(59)	6816(11580)
ACS880-34-2270A-5	3xR8i + 2xBLCL-24-5 + 3xR8i	2179	1900	1500	1698	1500	1200	78	235438(69)	6816(11580)

$U_N = 690$  V (range 525 to 690 V). The power ratings are valid at nominal voltage 575 V (kW rated at 690 V).

Drive type	Frame size	Light duty use			Heavy duty use			Noise level [db(A)]	Heat dissipation [BTU(kW)]	Air flow [cfm(m <sup>3</sup> /h)]
		$I_{Ld}$ [A]	$P_{Ld}$ [HP]	$P_{Ld}$ [kW]	$I_{Hd}$ [A]	$P_{Hd}$ [HP]	$P_{Hd}$ [kW]			
ACS880-34-0320A-7	R8i + BLCL-13-7 + R8i	307	300	250	239	250	200	75	54594(16)	2213(3760)
ACS880-34-0390A-7	R8i + BLCL-13-7 + R8i	374	350	355	292	300	250	75	64831(19)	2213(3760)
ACS880-34-0580A-7	R8i + BLCL-15-7 + R8i	557	600	500	434	450	400	75	88716(26)	2213(3760)
ACS880-34-0770A-7	2xR8i + BLCL-24-7 + 2xR8i	739	700	710	576	600	560	77	116013(34)	4250(7220)
ACS880-34-0950A-7	2xR8i + BLCL-25-7 + 2xR8i	912	1000	800	711	700	710	77	136486(40)	4250(7220)
ACS880-34-1130A-7	2xR8i + BLCL-25-7 + 2xR8i	1085	1100	1000	845	1000	800	77	163783(48)	4250(7220)
ACS880-34-1450A-7	3xR8i + 2xBLCL-24-7 + 3xR8i	1392	1500	1300	1085	1100	1000	78	214965(63)	6816(11580)
ACS880-34-1680A-7	3xR8i + 2xBLCL-24-7 + 3xR8i	1613	1750	1500	1257	1250	1200	78	252499(74)	6816(11580)
ACS880-34-2230A-7	4xR8i + 2xBLCL-25-7 + 4xR8i	2141	2250	2000	1668	1750	1600	79	324153(95)	8499(14440)

#### Light-duty use

$I_{Ld}$  Continuous current allowing 110%  $I_{Ld}$  for 1 minute every 5 minutes to 40 °C.

$P_{Ld}$  Typical motor power in light-overload use.

#### Heavy-duty use

$I_{Hd}$  Continuous current allowing 150%  $I_{Hd}$  for 1 minute every 5 minutes to 40 °C.

$P_{Hd}$  Typical motor power in heavy-duty use.

The ratings apply to 40 °C ambient temperature.

At higher temperatures (up to 55 °C) the derating is 1%/1 °C.





# Multidrive modules

## ACS880-x04

The module selection for building multidrive configurations includes inverter, diode supply, IGBT supply, regenerative rectifier, brake and DC-DC converter units. Their modular design and side-by-side mounting make installation fast and easy. Modules with bigger frame sizes are equipped with wheels so they can easily be moved in or out of the cabinet for maintenance purposes. This concept also allows pre-installation of the power cables inside the empty cabinet.

Multidrives can be used wherever several motors form part of a single process. With a compact module design and high power density, the single supply and DC bus arrangement with multiple inverters provides many advantages:

- Savings in cabling, installation and maintenance costs
- Reduced component count and increased reliability
- Reduced line power and line currents. As the energy circulates over the common DC bus, all energy is not taken from the supply network. Energy circulation can be used for motor-to-motor braking without the need for a braking chopper or regenerative supply unit.

### Inverter units (INU)

Inverter units are DC supplied and have built-in capacitors for smoothing the DC voltage. The electrical connection to the common DC bus is fuse protected. An optional switch can be selected to disconnect the whole drive unit from the DC bus.

### Diode supply units (DSU)

A diode supply unit is used in non-regenerative drive systems to convert three-phase AC voltage to DC voltage. Two types of diode supply unit are available: an uncontrolled 6-pulse diode supply unit (D6D to D8D) and a half-controlled diode supply unit with thyristor charging (D7T and D8T). The D<sub>x</sub>T modules can be connected parallel and are able to charge the inverters without external components.

### IGBT supply units (ISU)

IGBT supply units are used in regenerative drive systems to convert three-phase AC voltage to DC voltage. The ISU consists of RX<sub>i</sub> and LCL filter modules. It can operate in both motoring and generating modes. The DC voltage is constant and the line current is sinusoidal. The unit provides the same features described for the ACS880-11/14 regenerative drives on page 29 (unity power factor, DC voltage boost, <3% THD).

### Regenerative rectifier unit (RRU)

A regenerative rectifier unit is used in regenerative drive systems to convert three-phase AC voltage to DC voltage. The RRU consists of R8<sub>i</sub> and L filter modules. During motoring the input current flows through the diodes to the DC bus and the supply unit works as a diode bridge. In regeneration the current flows from the DC bus through the IGBTs to the supply network. The IGBTs are switched to conduct only once during each network voltage cycle. This reduces switching losses and enables high input and output powers of the R8<sub>i</sub> module. Unlike with a thyristor bridge, the IGBTs can be switched off at any time which improves reliability.

### Brake unit

A brake unit is used for resistor braking. It handles the energy generated by decelerating motors, during an emergency stop for example. Whenever the voltage in the common DC bus exceeds a certain limit, a braking chopper connects the bus to a braking resistor.

### DC/DC converter (DDC)

A DC/DC converter can transfer energy from a common DC bus of a drive system into an external energy storage. From there it can transfer the energy back to the DC bus when needed. Energy storages can be batteries or super capacitors. Applications for energy storage and reuse are found in a range of industries, such as marine (heave and peak load compensation), process industry (electrical braking or DC bus voltage stabilization) and automotive (charging systems). The converter unit consists of R8<sub>i</sub> and DCL filter modules.

01 Multidrive configuration with supply unit, DC bus and multiple inverters

02 ACS880-104 inverters modules, frame sizes R1i to R8i

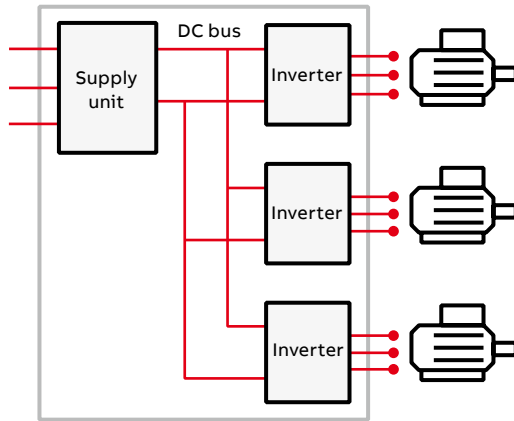

01

#### Multidrive modules, ACS880-x04

- Power ratings:
  - Inverter units (INU): 1.5 to 3500 HP (1.5 to 3200 kW)
  - Diode supply units (DSU): 55 to 5445 kVA
  - IGBT supply units (ISU): 5.5 to 3679 kVA
  - Regenerative rectifier units (RRU): 416 to 4135 kVA
- Brake units:
  - 1-phase  $P_{cont}$  70 to 714 kW,
  - 3-phase  $P_{cont}$  500 to 6500 kW
- DC-DC converters (DDC): 305 to 1146 kW
- Voltage range: 380 to 690 V
- Enclosure class: UL (NEMA) Type Open / IP00
- All multidrive modules come with a control unit.



02

The same control units are used with all ACS880 drives. They have three slots for option modules, such as I/O extension and communication protocol adapters.

#### Main options:

- Detailed documentation for cabinet installation
- Cabinet accessory kits
- Marine type approvals
- I/O extension modules, see page 63
- Communication protocol adapters, see page 63
- Application specific softwares, see page 16
- Speed feedback interfaces, see page 64
- Remote monitoring options, see page 65
- Functional safety modules, see page 67
- Brake choppers and resistors, see page 72
- Du/dt filters, see page 77

The drives have an extensive selection of built-in features and options. See page 87.

#### Highlights

- Compact design for easy cabinet assembly and maintenance
- High power density
- Multidrive concept with one supply unit and DC bus arrangement with multiple inverters which reduces line power, cabinet size and investment costs
- Mechanical and electrical accessories which provide full design to install the modules into Rittal VX25 cabinets

# Liquid-cooled multidrive modules

## ACS880-x04LC, ACS880-1007LC/1604LC

The compact and robust ACS880 liquid-cooled drive modules with direct liquid cooling are an ultimate solution for various applications where space savings, silent operation and/or durability in harsh environments is a must.

### **Advanced liquid cooling and compact design**

Liquid cooling offers easy heat transfer without air filtering problems. Since the coolant takes care of 98% of the heat losses, no additional filtered air cooling is needed. This increases the total efficiency of the drive installation.

The ACS880 liquid-cooled modules have high power density making their design extremely compact. The small footprint enables significant space and weight reduction.

### **Optimal solution for different environments**

The possibility to have a totally enclosed cabinet structure makes the ACS880 liquid-cooled modules perfect for harsh environmental conditions. The modules can even be integrated into explosion-proof enclosures for installations in hazardous locations.

The ACS880 liquid-cooled offering fulfills marine and offshore requirements. The modules have marine type approvals from various key classification bodies.

As the direct liquid cooling enables silent operation, the ACS880 liquid-cooled modules are suitable for applications where noise levels are an important environmental factor.

### **Simple and cost-efficient installation**

The high-efficient liquid cooling removes the need for air-conditioning in the installation rooms, bringing the installation and operation costs down. As there is no need for additional air conditioning devices or air ducts, the installation is significantly simplified.

The used coolant type is Antifrogen® L, by Clariant International Ltd, cooling liquid with glycol and inhibitor. It is a ready-made, commercially available mix, which enables easy commissioning and prevents the risk of errors in coolant selection.

### **Wide selection of drive module products**

Covering a wide power range with a very small footprint, the liquid-cooled ACS880 is available for single and multidrive purposes. The product family includes compact diode supply, IGBT supply, inverter units and DC/DC converters. Optional stand-alone liquid cooling units are offered for cooling the modules. All piping and heat exchangers can be combined to the same closed-loop cooling system.

In addition, ABB offers an extensive selection of electrical and mechanical installation accessories, including piping components. These minimize cabinet engineering and assembly effort and ensure a safe, tested cabinet design.

—  
01 ACS880-304LC  
diode supply module,  
frame D8D

—  
02 ACS880-104LC  
inverter module, frame  
R8i. The same module  
is used in -204LC IGBT  
supply and -1604LC  
DC/DC converter units.

—  
03 ACS880-1007LC  
liquid cooling unit,  
70 kW



01



02



03

#### Liquid-cooled modules, ACS880-x04LC

- Power ratings:  
Diode supply units (DSU): 745 to 3466 kW  
IGBT supply units (ISU): 430 to 3502 kVA  
Inverter units (INU): 300 to 3300 HP (250 to 3000 kW)  
Brake choppers: 54 to 714 kW  
DC/DC converters: 400 to 1800 A
- Enclosure class: UL (NEMA) Type Open / IP00
- 3-phase inverter modules with internal du/dt filters as standard
- Quick connectors for motor cable output connection

#### Main options:

- Support for 6/12/24-pulse network configurations
- Electrical and mechanical installation accessories including piping components – full design for Rittal VX25 cabinet installations
- Wide selection of ACS880 options

#### Liquid cooling unit, ACS880-1007LC

- Power ratings: 70 to 195 kW cooling power

- Enclosure class: UL (NEMA) Type 12 / IP54
- Stand-alone cabinet with cooling pipe connections on the right side
- Built-in cabinet heater
- Heat exchanger for industrial cooling water
- Fulfills marine requirements
- Single pump and two pump versions
- Redundant pump version
- Different piping solutions and sea water heat exchanger available as engineered variants

The drives have an extensive selection of built-in features and options. See page 87.

#### Highlights

- Advanced liquid cooling which reduces the need for air cooling in installation rooms
- High power density with compact design
- Optimized design for cabinet assembly
- Silent operation
- Suitable for harsh environments
- Marine approvals from various key classification bodies

# Ratings, types and voltages

## Inverter units, air-cooled, ACS880-104, 500 V

$U_N = 500$  V (range 380 to 500 V). The power ratings are valid at nominal voltage 480 V.

Drive type	Frame size	Light duty use			Heavy duty use			Noise level [db(A)]	Heat dissipation [BTU(kW)]	Air flow [cfm(m <sup>3</sup> /h)]
		$I_{Ld}$ [A]	$P_{Ld}$ [HP]	$P_{Ld}$ [kW]	$I_{Hd}$ [A]	$P_{Hd}$ [HP]	$P_{Hd}$ [kW]			
<b>Inverter modules (inU), ACS880-104</b>										
ACS880-104-003A6-5	R1i	3.4	2	1.5	3	1.5	1.5	47	205(0.06)	14(24)
ACS880-104-004A8-5	R1i	4.5	3	2.2	4	2	1.5	47	239(0.07)	14(24)
ACS880-104-006A0-5	R1i	5.5	3	3	5	3	2.2	47	273(0.08)	14(24)
ACS880-104-008A0-5	R1i	7.6	5	4	6	3	3	47	307(0.09)	14(24)
ACS880-104-0011A-5	R2i	9.7	7.5	5.5	9	5	4	39	444(0.13)	28(48)
ACS880-104-0014A-5	R2i	13	10	7.5	11	7.5	5.5	39	512(0.15)	28(48)
ACS880-104-0018A-5	R2i	16.8	10	11	14	10	7.5	39	614(0.18)	28(48)
ACS880-104-0025A-5	R3i	23	15	15	19	10	11	63	785(0.23)	84(142)
ACS880-104-0030A-5	R3i	28	20	18.5	24	15	15	63	955(0.28)	84(142)
ACS880-104-0035A-5	R3i	32	25	22	29	20	18.5	63	1092(0.32)	84(142)
ACS880-104-0050A-5	R3i	46	30	30	44	30	22	71	1638(0.48)	118(200)
ACS880-104-0061A-5	R4i	57	40	37	52	40	30	70	1877(0.55)	171(290)
ACS880-104-0078A-5	R4i	74	50	45	69	50	45	70	2218(0.65)	171(290)
ACS880-104-0094A-5	R4i	90	60	55	75	50	45	70	2730(0.80)	171(290)
ACS880-104-0110A-5	R6i	108	75	75	85	60	55	71	3412(1.0)	383(650)
ACS880-104-0140A-5	R6i	131	100	90	102	75	55	71	4095(1.2)	383(650)
ACS880-104-0170A-5	R6i	158	125	110	123	100	75	71	5118(1.5)	383(650)
ACS880-104-0200A-5	R6i	189	150	132	147	100	90	71	6142(1.8)	383(650)
ACS880-104-0240A-5	R6i	230	200	160	180	150	110	71	6824(2.0)	383(650)
ACS880-104-0300A-5	R7i	290	250	200	226	150	132	72	9213(2.7)	553(940)
ACS880-104-0340A-5	R7i	326	250	200	254	200	160	72	10919(3.2)	553(940)
ACS880-104-0440A-5	R8i	422	350	250	329	250	200	72	16037(4.7)	765(1300)
ACS880-104-0590A-5	R8i	566	400	355	441	350	250	72	21496(6.3)	765(1300)
ACS880-104-0740A-5	R8i	710	600	450	554	400	355	72	27638(8.1)	765(1300)
ACS880-104-0810A-5	R8i	778	600	500	606	450	400	72	31733(9.3)	765(1300)
ACS880-104-1150A-5	2xR8i	1104	900	710	860	700	560	74	40946(12)	1530(2600)
ACS880-104-1450A-5	2xR8i	1392	1200	900	1085	900	710	74	54594(16)	1530(2600)
ACS880-104-1580A-5	2xR8i	1517	1250	1000	1182	1000	800	74	61419(18)	1530(2600)
ACS880-104-2150A-5	3xR8i	2064	1750	1400	1608	1250	1100	76	81891(24)	2295(3900)
ACS880-104-2350A-5	3xR8i	2256	2000	1500	1758	1500	1200	76	92128(27)	2295(3900)
ACS880-104-3110A-5	4xR8i	2986	2500	2000	2326	2000	1600	76	122837(36)	3061(5200)
ACS880-104-3860A-5	5xR8i	3706	3000	2400	2887	2500	2000	77	150134(44)	3826(6500)
ACS880-104-4610A-5	6xR8i	4426	3500	2800	3448	3000	2400	78	180844(53)	4591(7800)

### Light-duty use

$I_{Ld}$  Continuous current allowing 110%  $I_{Ld}$  for 1 minute every 5 minutes to 40 °C.

$P_{Ld}$  Typical motor power in light-overload use.

### Heavy-duty use

$I_{Hd}$  Continuous current allowing 150%  $I_{Hd}$  for 1 minute every 5 minutes to 40 °C.

$P_{Hd}$  Typical motor power in heavy-duty use.

The ratings apply to 40 °C ambient temperature. At higher temperatures (up to 50 °C) the derating is 1%/1 °C.

<sup>1)</sup> +A003 Uncontrolled diode bridge, +A018 Half-controlled diode bridge, +A004 12-pulse DSU.

# Ratings, types and voltages

## Supply units, air-cooled, ACS880-x04, 500 V

$U_N = 500 \text{ V}$  (range 380 to 500 V). The power ratings are valid at nominal voltage 400 V.

Drive type	Frame size	Nominal ratings			Light duty use		Heavy duty use		Noise level	Heat dissipation	Air flow
		$I_N$ AC [A]	$I_{max}$ DC [A]	$S_N$ (KVA)	$I_{Ld}$ DC [A]	$P_{Ld}$ DC [kW]	$I_{Hd}$ DC [A]	$P_{Hd}$ DC [kW]			
<b>IGBT supply modules (ISU), ACS880-204</b>											
ACS880-204-006A6-5	R1i + WFU-01	6.6	10.4	5.7	7.7	5.4	6	4.2	47	751(0.22)	14(24)
ACS880-204-0015A-5	R2i + WFU-02	15	24	13	17	12	14	10	39	1706(0.50)	28(48)
ACS880-204-0029A-5	R3i + WFU-11	29	46	25	34	24	26	19	63	3310(0.97)	37(63)
ACS880-204-0041A-5	R3i + WFU-21	41	65	35	48	34	37	26	71	4743(1.39)	118(200)
ACS880-204-0077A-5	R4i + WFU-22	77	121	66	90	63	70	49	70	8803(2.58)	171(290)
ACS880-204-0210A-5	R6i + ALCL-05-5	210	331	182	244	173	190	135	72	14331(4.2)	677(1150)
ACS880-204-0400A-5	R8i + BLCL-13-5	396	624	343	461	326	359	254	72	31392(9.2)	1295(2200)
ACS880-204-0530A-5	R8i + BLCL-13-5	531	837	460	618	437	482	341	72	39240(11.5)	1295(2200)
ACS880-204-0730A-5	R8i + BLCL-15-5	729	1149	631	849	600	661	468	72	56983(16.7)	1295(2200)
ACS880-204-1040A-5	2xR8i + BLCL-24-5	1035	1631	896	1205	852	939	664	74	70973(20.8)	2413(4100)
ACS880-204-1420A-5	2xR8i + BLCL-25-5	1422	2241	1231	1655	1170	1290	912	74	100317(29.4)	2413(4100)
ACS880-204-2120A-5	3xR8i + 2xBLCL-24-5	2115	3334	1832	2462	1741	1918	1356	76	149793(43.9)	4061(6900)
ACS880-204-2800A-5	4xR8i + 2xBLCL-25-5	2799	4412	2424	3258	2304	2539	1795	76	199610(58.5)	4826(8200)
ACS880-204-4150A-5	6xR8i + 3xBLCL-25-5	4149	6540	3593	4829	3415	3763	2661	78	298904(87.6)	7240(12300)
<b>Regenerative rectifier units (RRU), ACS880-904</b>											
ACS880-904-0600A-5	1xR8i + BL-15-5	600	955	520	698	471	544	367	72	29003(8.5)	1295(2200)
ACS880-904-0900A-5	1xR8i + BL-15-5	900	1433	779	1047	707	816	551	72	44358(13.0)	1295(2200)
ACS880-904-1180A-5	2xR8i + BL-25-5	1180	1879	1022	1374	927	1070	722	74	54935(16.1)	2413(4100)
ACS880-904-1770A-5	2xR8i + BL-25-5	1770	2818	1533	2060	1391	1605	1084	74	87351(25.6)	2413(4100)
ACS880-904-2310A-5	4xR8i + 2xBL-25-5	2310	3678	2001	2689	1815	2095	1414	76	109871(32.2)	4826(8200)
ACS880-904-3460A-5	4xR8i + 2xBL-25-5	3460	5509	2996	4027	2719	3138	2118	76	174360(51.1)	4826(8200)
<b>Diode supply modules (DSU), ACS880-304</b>											
<b>6-pulse diode <sup>1)</sup></b>											
ACS880-304-0080A-5+A003	D6D	80	137	69	94	63	78	53	62	2730(0.8)	218(370)
ACS880-304-0170A-5+A003	D6D	173	297	150	203	137	170	114	62	4436(1.3)	218(370)
ACS880-304-0330A-5+A003	D7D	327	561	283	384	260	320	216	62	6824(2.0)	424(720)
ACS880-304-0490A-5+A003	D7D	490	840	424	576	389	480	324	62	10236(3.0)	424(720)
ACS880-304-0650A-5+A003	D8D	653	1120	566	768	518	640	432	65	15355(4.5)	530(900)
ACS880-304-0980A-5+A003	D8D	980	1680	849	1152	778	960	648	65	20473(6.0)	530(900)
ACS880-304-0650A-5+A018	D8T	653	1120	566	768	518	598	404	72	15696(4.6)	765(1300)
ACS880-304-0980A-5+A018	D8T	980	1680	849	1152	778	898	606	72	22520(6.6)	765(1300)
ACS880-304-1210A-5+A018	2xD8T	1215	2083	1052	1428	964	1113	751	74	31392(9.2)	1530(2600)
ACS880-304-1820A-5+A018	2xD8T	1823	3125	1579	2143	1446	1670	1127	74	45382(13.3)	1530(2600)
ACS880-304-2730A-5+A018	3xD8T	2734	4687	2368	3214	2170	2504	1690	76	67902(19.9)	2295(3900)
ACS880-304-3640A-5+A018	4xD8T	3645	6250	3157	4285	2893	3339	2254	76	90763(26.6)	3061(5200)
ACS880-304-4560A-5+A018	5xD8T	4557	7812	3946	5357	3616	4174	2817	77	113624(33.3)	3826(6500)
ACS880-304-5470A-5+A018	6xD8T	5468	9374	4735	6428	4339	5009	3381	78	136486(40.0)	4591(7800)
<b>12-pulse diode <sup>1)</sup></b>											
ACS880-304-0910A-5+A004+A018	2xD7T	912	1562	790	1071	750	835	584	74	28662(8.4)	1059(1800)
ACS880-304-1210A-5+A004+A018	2xD8T	1215	2083	1052	1428	1000	1113	779	74	31392(9.2)	1530(2600)
ACS880-304-1820A-5+A004+A018	2xD8T	1823	3125	1579	2143	1500	1670	1169	74	45382(13.3)	1530(2600)
ACS880-304-2430A-5+A004+A018	4xD8T	2430	4166	2104	2857	2000	2226	1558	76	62783(18.4)	3061(5200)
ACS880-304-3640A-5+A004+A018	4xD8T	3645	6250	3157	4285	3000	3339	2337	76	90763(26.6)	3061(5200)
ACS880-304-5470A-5+A004+A018	6xD8T	5468	9374	4735	6428	4500	5009	3506	78	136486(40.0)	4591(7800)



# Ratings, types and voltages

## Inverter units, air-cooled, ACS880-104, 690 V

$U_N = 690$  V (range 525 to 690 V). The power ratings are valid at nominal voltage 575 V (kW rated at 690 V).

Drive type	Frame size	Light duty use			Heavy duty use			Noise level	Heat dissipation	Air flow
		$I_{Ld}$ [A]	$P_{Ld}$ [HP]	$P_{Ld}$ [kW]	$I_{Hd}$ [A]	$P_{Hd}$ [HP]	$P_{Hd}$ [kW]			
<b>Inverter modules (inU), ACS880-104</b>										
ACS880-104-007A3-7	R5i	6.9	7.5	5.5	5.6	5	4	62	751(0.22)	165(280)
ACS880-104-009A8-7	R5i	9.3	10	7.5	7.3	7.5	5.5	62	955(0.28)	165(280)
ACS880-104-014A2-7	R5i	13.5	15	11	9.8	10	7.5	62	1365(0.40)	165(280)
ACS880-104-0018A-7	R5i	17.1	15	15	14.2	15	11	62	1672(0.49)	165(280)
ACS880-104-0022A-7	R5i	20.9	20	18.5	18	20	15	62	1979(0.58)	165(280)
ACS880-104-0027A-7	R5i	25.7	25	22	22	20	18.5	62	2252(0.66)	165(280)
ACS880-104-0035A-7	R5i	33.3	30	30	27	25	22	62	2934(0.86)	165(280)
ACS880-104-0042A-7	R5i	39.9	40	37	35	30	30	62	3412(1.00)	165(280)
ACS880-104-0052A-7	R5i	49.4	50	45	42	40	37	62	3822(1.12)	165(280)
ACS880-104-0062A-7	R6i	60	60	55	46	50	45	71	2730(0.8)	383(650)
ACS880-104-0082A-7	R6i	79	75	75	61	60	55	71	3753(1.1)	383(650)
ACS880-104-0100A-7	R6i	95	100	90	74	75	75	71	4436(1.3)	383(650)
ACS880-104-0130A-7	R6i	120	125	110	94	125	75	71	5118(1.5)	383(650)
ACS880-104-0140A-7	R6i	138	150	132	108	150	90	71	6142(1.8)	383(650)
ACS880-104-0190A-7	R6i	184	200	160	144	150	132	71	8530(2.5)	383(650)
ACS880-104-0220A-7	R7i	208	200	200	162	150	160	72	9554(2.8)	553(940)
ACS880-104-0270A-7	R7i	259	250	250	202	200	200	72	11260(3.3)	553(940)
ACS880-104-0340A-7	R8i	326	350	250	254	250	200	72	17743(5.2)	765(1300)
ACS880-104-0410A-7	R8i	394	400	355	307	300	250	72	20814(6.1)	765(1300)
ACS880-104-0530A-7	R8i	509	500	450	396	400	355	72	26956(7.9)	765(1300)
ACS880-104-0600A-7	R8i	576	600	560	449	450	400	72	30709(9.0)	765(1300)
ACS880-104-0800A-7	2xR8i	768	800	710	598	600	560	74	40946(12)	1530(2600)
ACS880-104-1030A-7	2xR8i	989	1000	900	770	800	710	74	51182(15)	1530(2600)
ACS880-104-1170A-7	2xR8i	1123	1250	1000	875	900	800	74	61419(18)	1530(2600)
ACS880-104-1540A-7	3xR8i	1478	1500	1400	1152	1250	1100	76	78479(23)	2295(3900)
ACS880-104-1740A-7	3xR8i	1670	1750	1600	1302	1400	1200	76	88716(26)	2295(3900)
ACS880-104-2300A-7	4xR8i	2208	2250	2000	1720	1750	1600	76	119425(35)	3061(5200)
ACS880-104-2860A-7	5xR8i	2746	2900	2400	2139	2250	2000	77	146722(43)	3826(6500)
ACS880-104-3420A-7	6xR8i	3283	3500	3200	2558	2700	2400	78	177431(52)	4591(7800)

### Light-duty use

$I_{Ld}$  Continuous current allowing 110%  $I_{Ld}$  for 1 minute every 5 minutes to 40 °C.

$P_{Ld}$  Typical motor power in light-overload use.

### Heavy-duty use

$I_{Hd}$  Continuous current allowing 150%  $I_{Hd}$  for 1 minute every 5 minutes to 40 °C.

$P_{Hd}$  Typical motor power in heavy-duty use.

The ratings apply to 40 °C ambient temperature. At higher temperatures (up to 50 °C) the derating is 1%/1 °C.

<sup>1)</sup> +A018 half-controlled diode bridge, +A004 12-pulse DSU

# Ratings, types and voltages

## Supply units, air-cooled, ACS880-x04, 690 V

$U_N = 690$  V (range 525 to 690 V). The power ratings are valid at nominal voltage 690 V.

Drive type	Frame size	Nominal ratings			Light duty use		Heavy duty use		Noise level	Heat dissipation	Air flow
		$I_N$ AC [A]	$I_{max}$ DC [A]	$S_N$ (KVA)	$I_{Ld}$ DC [A]	$P_{Ld}$ DC [kW]	$I_{Hd}$ DC [A]	$P_{Hd}$ DC [kW]			
<b>IGBT supply modules (ISU), ACS880-204</b>											
ACS880-204-0310A-7	R8i + BLCL-13-7	306	557	366	356	348	278	271	72	40263(11.8)	1295(2200)
ACS880-204-0370A-7	R8i + BLCL-13-7	369	671	441	430	419	335	327	72	46064(13.5)	1295(2200)
ACS880-204-0540A-7	R8i + BLCL-15-7	540	982	645	629	613	490	478	72	60054(17.6)	1295(2200)
ACS880-204-0720A-7	2xR8i + BLCL-24-7	720	1309	860	838	818	653	637	74	79162(23.2)	2413(4100)
ACS880-204-1050A-7	2xR8i + BLCL-25-7	1053	1915	1258	1226	1196	955	932	74	108165(31.7)	2413(4100)
ACS880-204-1570A-7	3xR8i + 2xBLCL-24-7	1566	2848	1872	1823	1779	1420	1386	76	169242(49.6)	4061(6900)
ACS880-204-2070A-7	4xR8i + 2xBLCL-25-7	2070	3765	2474	2409	2351	1877	1832	76	214965(63.0)	4826(8200)
ACS880-204-3080A-7	6xR8i + 3xBLCL-25-7	3078	5598	3679	3583	3496	2792	2724	78	322106(94.4)	7240(12300)
<b>Regenerative rectifier units (RRU), ACS880-904</b>											
ACS880-904-0600A-7	1xR8i + BL-15-7	600	1102	717	698	651	544	507	72	33439(9.8)	1295(2200)
ACS880-904-0900A-7	1xR8i + BL-15-7	900	1653	1076	1048	976	816	760	72	48794(14.3)	1295(2200)
ACS880-904-1180A-7	2xR8i + BL-25-7	1180	2168	1410	1374	1279	1070	997	74	63125(18.5)	2413(4100)
ACS880-904-1770A-7	2xR8i + BL-25-7	1770	3252	2115	2060	1919	1605	1495	74	95881(28.1)	2413(4100)
ACS880-904-2310A-7	4xR8i + 2xBL-25-7	2310	4244	2761	2689	2505	2095	1952	76	126590(37.1)	4826(8200)
ACS880-904-3460A-7	4xR8i + 2xBL-25-7	3460	6356	4135	4027	3752	3138	2923	76	191762(56.2)	4826(8200)
<b>Diode supply modules (DSU), ACS880-304</b>											
<b>6-pulse diode <sup>1)</sup></b>											
ACS880-304-0570A-7+A018	D8T	572	980	684	672	626	524	488	72	15355(4.5)	765(1300)
ACS880-304-0820A-7+A018	D8T	817	1400	976	960	894	748	697	72	19790(5.8)	765(1300)
ACS880-304-1060A-7+A018	2xD8T	1064	1823	1272	1250	1164	974	907	74	30709(9.0)	1530(2600)
ACS880-304-1520A-7+A018	2xD8T	1519	2604	1815	1786	1663	1391	1296	74	43334(12.7)	1530(2600)
ACS880-304-2280A-7+A018	3xD8T	2279	3906	2724	2678	2495	2087	1944	76	65172(19.1)	2295(3900)
ACS880-304-3040A-7+A018	4xD8T	3038	5208	3631	3571	3327	2783	2592	76	87010(25.5)	3061(5200)
ACS880-304-3800A-7+A018	5xD8T	3797	6510	4538	4464	4158	3478	3240	77	109189(32.0)	3826(6500)
ACS880-304-4560A-7+A018	6xD8T	4557	7812	5446	5357	4990	4174	3888	78	131026(38.4)	4591(7800)
<b>12-pulse diode <sup>1)</sup></b>											
ACS880-304-0760A-7+A004+A018	2xD7T	760	1302	908	893	862	696	672	74	26273(7.7)	1059(1800)
ACS880-304-1060A-7+A004+A018	2xD8T	1064	1823	1272	1250	1207	974	941	74	30709(9.0)	1530(2600)
ACS880-304-1520A-7+A004+A018	2xD8T	1519	2604	1815	1786	1725	1391	1344	74	43334(12.7)	1530(2600)
ACS880-304-2130A-7+A004+A018	4xD8T	2127	3646	2542	2500	2415	1948	1882	76	61760(18.1)	3061(5200)
ACS880-304-3040A-7+A004+A018	4xD8T	3038	5208	3631	3571	3450	2783	2688	76	87010(25.5)	3061(5200)
ACS880-304-4560A-7+A004+A018	6xD8T	4557	7812	5446	5357	5175	4174	4032	78	131026(38.4)	4591(7800)

# Ratings, types and voltages

## DC/DC converter, air-cooled, ACS880-1604

$U_N = 500$  V (range 380 to 500 V). The power ratings are valid at nominal voltage 500 V.

Converter type	Frame size	Filter type	No overload use			Short time use (10 s/60 s)			Heavy duty use (1 min/5 min)		Noise level [db(A)]	Heat dissipation [BTU(kW)]	Air flow [cfm(m <sup>3</sup> /h)]	
			$I_{dc}$ input DC [A]	$I_{rms}$ output DC [A]	$P_{contmax}$ [kW]	$I_{max}$ output DC [A]	$I_{p2p}$ [A]	$I_{short\ time}$ [A]	$P_{short\ time}$ [kW]	$I_{Hd}$ [A]				$P_{Hd}$ [kW]
ACS880-1604-0600A-5	R8i	BDCL-14-5	600	600	382	900	27	450	286	510	324	74	20473(6.0)	1295(2200)
ACS880-1604-0900A-5	R8i	BDCL-15-5	900	900	573	1350	41	675	429	765	487	74	31050(9.1)	1295(2200)
ACS880-1604-1200A-5	2xR8i	2xBDCL-14-5	1200	1200	764	1800	14	899	572	1020	649	76	41287(12.1)	2590(4400)
ACS880-1604-1800A-5	2xR8i	2xBDCL-15-5	1800	1800	1146	2700	20	1349	859	1529	973	76	64148(18.8)	2590(4400)

$U_N = 690$  V (range 525 to 690 V). The power ratings are valid at nominal voltage 690 V.

Converter type	Frame size	Filter type	No overload use			Short time use (10 s/60 s)			Heavy duty use (1 min /5 min)		Noise level [db(A)]	Heat dissipation [BTU(kW)]	Air flow [cfm(m <sup>3</sup> /h)]	
			$I_{dc}$ input DC [A]	$I_{rms}$ output DC [A]	$P_{contmax}$ [kW]	$I_{max}$ output DC [A]	$I_{p2p}$ [A]	$I_{short\ time}$ [A]	$P_{short\ time}$ [kW]	$I_{Hd}$ [A]				$P_{Hd}$ [kW]
ACS880-1604-0400A-7	R8i	BDCL-14-7	400	400	351	600	38	300	263	340	298	74	21838(6.4)	1295(2200)
ACS880-1604-0600A-7	R8i	BDCL-15-7	600	600	527	900	56	450	395	510	448	74	36169(10.6)	1295(2200)
ACS880-1604-0800A-7	2xR8i	2xBDCL-14-7	800	800	703	1200	19	600	527	680	597	76	43675(12.8)	2590(4400)
ACS880-1604-1200A-7	2xR8i	2xBDCL-15-7	1200	1200	1054	1800	28	899	790	1020	895	76	73361(21.5)	2590(4400)

### Ratings

#### No overload use

$I_{dc}$ input	Maximum continuous input DC current from DC bus
$I_{rms}$ output	Maximum continuous output current to/from energy storage
$P_{contmax}$	Maximum continuous output power to/from energy storage
$I_{max}$ output	Maximum instantaneous output current to/from energy storage
$I_{p2p}$	Maximum output ripple current to/from energy storage

#### Short time / heavy overload cycle

$I_{short\ time}$	Continuous output current allowing 10 s of $I_{MAX}$ (DC) every 60 seconds
$P_{short\ time}$	Continuous output power allowing 10 s of $I_{MAX}$ (DC) every 60 seconds
$I_{Hd}$	Continuous output current allowing overload of 150% $I_{hd}$ for 1 min every 5 min
$P_{Hd}$	Continuous output power allowing 150% $I_{hd}$ for 1 min every 5 min

# Ratings, types and voltages

## Inverter units, liquid-cooled, ACS880-104LC, 690 V

$U_N = 690$  V (range 525 to 690 V). The power ratings are valid at nominal voltage 575 V (kW rated at 690 V).

Inverter module type	Frame size	Light duty use			Heavy duty use			Noise level <sup>1)</sup>	Losses <sup>2)</sup>	Coolant flow rate
		$I_{Ld}$ [A]	$P_{Ld}$ [HP]	$P_{Ld}$ [kW]	$I_{Hd}$ [A]	$P_{Hd}$ [HP]	$P_{Hd}$ [kW]			
<b>Liquid-cooled inverter units [inU], ACS880-104LC</b>										
ACS880-104LC-0390A-7	R8i	374	400	355	292	300	250	63	17402(5.1)	4.2(16)
ACS880-104LC-0430A-7	R8i	413	400	355	322	350	250	63	19108(5.6)	4.2(16)
ACS880-104LC-0480A-7	R8i	461	500	400	359	350	315	63	21838(6.4)	4.2(16)
ACS880-104LC-0530A-7	R8i	509	500	450	396	400	355	63	24567(7.2)	4.2(16)
ACS880-104LC-0600A-7	R8i	576	600	560	449	450	400	63	27980(8.2)	4.2(16)
ACS880-104LC-0670A-7	R8i	643	700	630	501	500	450	63	32074(9.4)	4.2(16)
ACS880-104LC-0750A-7	R8i	720	750	710	561	600	500	63	36851(10.8)	4.2(16)
ACS880-104LC-0850A-7	R8i	816	800	800	636	600	560	63	43334(12.7)	4.2(16)
ACS880-104LC-1030A-7	2xR8i	989	1000	900	770	800	710	66	47770(14.0)	8.5(32)
ACS880-104LC-1170A-7	2xR8i	1123	1200	1100	875	900	800	66	54594(16.0)	8.5(32)
ACS880-104LC-1310A-7	2xR8i	1258	1300	1200	980	1000	900	66	62783(18.4)	8.5(32)
ACS880-104LC-1470A-7	2xR8i	1411	1500	1200	1100	1100	1000	66	72337(21.2)	8.5(32)
ACS880-104LC-1660A-7	2xR8i	1594	1700	1400	1242	1300	1200	66	84621(24.8)	8.5(32)
ACS880-104LC-1940A-7	3xR8i	1862	2000	1800	1451	1500	1400	68	92810(27.2)	12.7(48)
ACS880-104LC-2180A-7	3xR8i	2093	2200	2000	1631	1750	1400	68	107141(31.4)	12.7(48)
ACS880-104LC-2470A-7	3xR8i	2371	2500	2300	1848	2000	1800	68	125908(36.9)	12.7(48)
ACS880-104LC-2880A-7	4xR8i	2765	2900	2700	2154	2300	2000	69	141604(41.5)	16.9(64)
ACS880-104LC-3260A-7	4xR8i	3130	3300	3000	2438	2600	2300	69	166171(48.7)	16.9(64)

### Light-duty use

$I_{Ld}$  Continuous current allowing 110%  $I_{Ld}$  for 1 minute every 5 minutes.

$P_{Ld}$  Typical motor power in light-overload use.

### Heavy-duty use

$I_{Hd}$  Continuous current allowing 150%  $I_{Hd}$  for 1 minute every 5 minutes

$P_{Hd}$  Typical motor power in heavy-duty use.

### Losses

$P_{loss}$  Power loss conducted to coolant and emitted to air

The ratings apply at an ambient air temperature of 45 °C and a coolant temperature of 40 °C.

# Ratings, types and voltages

## Supply units, liquid-cooled, ACS880-x04LC, 690 V

$U_N = 690$  V (range 525 to 690 V). The power ratings are valid at nominal voltage 690 V.

Supply module type	Frame size	Nominal ratings					Light overload use		Heavy-duty use		Noise level <sup>1)</sup>	Losses <sup>2)</sup>	Coolant flow rate
		$I_N$ AC [A]	$I_N$ DC [A]	$I_{max}$ DC [A]	$S_N$ (KVA)	$P_N$ DC [kW]	$I_{Ld}$ DC [A]	$P_{Ld}$ DC [kW]	$I_{Hd}$ DC [A]	$P_{Hd}$ DC [kW]			
<b>Liquid-cooled IGBT supply units (ISU), ACS880-204LC</b>													
ACS880-204LC-0360A-7	R8i+BLCL-15LC-7	360	436	655	430	426	419	409	327	319	58	24567(7.2)	9.5(36)
ACS880-204LC-0400A-7	R8i+BLCL-15LC-7	400	485	727	478	473	466	454	363	354	58	27297(8.0)	9.5(36)
ACS880-204LC-0450A-7	R8i+BLCL-15LC-7	450	546	818	538	532	524	511	408	398	58	31392(9.2)	9.5(36)
ACS880-204LC-0480A-7	R8i+BLCL-15LC-7	480	582	873	574	568	559	545	435	425	58	34804(10.2)	9.5(36)
ACS880-204LC-0560A-7	R8i+BLCL-15LC-7	560	679	1018	669	663	652	636	508	496	58	41628(12.2)	9.5(36)
ACS880-204LC-0620A-7	R8i+BLCL-15LC-7	620	752	1128	741	734	722	704	562	549	58	47429(13.9)	9.5(36)
ACS880-204LC-0700A-7	R8i+BLCL-15LC-7	700	849	1273	837	828	815	795	635	620	58	55959(16.4)	9.5(36)
ACS880-204LC-0770A-7	R8i+BLCL-15LC-7	770	934	1400	920	911	896	875	698	681	58	64148(18.8)	9.5(36)
ACS880-204LC-0930A-7	2xR8i+BLCL-24LC-7	930	1128	1691	1111	1100	1083	1056	843	823	59	64148(18.8)	19(72)
ACS880-204LC-1090A-7	2xR8i+BLCL-24LC-7	1090	1322	1982	1303	1290	1269	1238	989	965	59	76773(22.5)	19(72)
ACS880-204LC-1180A-7	2xR8i+BLCL-24LC-7	1180	1431	2146	1410	1396	1374	1340	1070	1044	59	87692(25.7)	19(72)
ACS880-204LC-1360A-7	2xR8i+BLCL-25LC-7	1360	1649	2473	1625	1609	1583	1545	1233	1204	59	94858(27.8)	19(72)
ACS880-204LC-1500A-7	2xR8i+BLCL-25LC-7	1500	1819	2728	1793	1775	1746	1704	1360	1328	59	107824(31.6)	19(72)
ACS880-204LC-1800A-7	3xR8i+BLCL-24LC-7	1800	2182	3274	2151	2130	2095	2045	1633	1593	61	122155(35.8)	34(128)
ACS880-204LC-2020A-7	3xR8i+BLCL-24LC-7	2020	2449	3674	2414	2390	2351	2294	1832	1788	61	142628(41.8)	34(128)
ACS880-204LC-2220A-7	3xR8i+BLCL-24LC-7	2220	2692	4038	2653	2627	2584	2522	2013	1965	61	161736(47.4)	34(128)
ACS880-204LC-2670A-7	4xR8i+BLCL-25LC-7	2670	3237	4856	3191	3159	3108	3033	2422	2363	61	182208(53.4)	38(144)
ACS880-204LC-2930A-7	4xR8i+BLCL-25LC-7	2930	3553	5329	3502	3467	3411	3328	2657	2593	61	206435(60.5)	38(144)

<sup>1)</sup> Noise level in a typical cabinet installation.

<sup>2)</sup> In totally enclosed cabinet 98% of losses are conducted to coolant, 2% to ambient air.

<sup>3)</sup> Coolant flow rate for the whole supply unit (supply module and filter).

$U_N = 690$  V (range 525 to 690 V). The power ratings are valid at nominal voltage 690 V.

Supply module type	Frame size	Nominal ratings					Light overload use		Heavy-duty use		Noise level <sup>4)</sup>	Losses <sup>5)</sup>	Coolant flow rate
		$I_N$ AC [A]	$I_N$ DC [A]	$I_{max}$ DC [A]	$S_N$ (KVA)	$P_N$ DC [kW]	$I_{Ld}$ DC [A]	$P_{Ld}$ DC [kW]	$I_{Hd}$ DC [A]	$P_{Hd}$ DC [kW]			
<b>Liquid-cooled diode supply units (DSU), ACS880-304LC <sup>6)</sup></b>													
ACS880-304LC-0820A-7+A019	D8D	820	1000	1500	980	932	960	895	800	745	63	11942(3.5)	3.2(12)
ACS880-304LC-1540A-7+A019	2xD8D	1540	1880	2820	1840	1752	1805	1682	1504	1401	63	22520(6.6)	3.2(12)
ACS880-304LC-2290A-7+A019	3xD8D	2290	2805	4208	2737	2614	2693	2509	2244	2091	63	33439(9.8)	6.3(24)
ACS880-304LC-3040A-7+A019	4xD8D	3040	3720	5580	3633	3466	3571	3328	2976	2773	63	44358(13.0)	6.3(24)

<sup>4)</sup> Noise level in a typical cabinet installation.

<sup>5)</sup> In totally enclosed cabinet 98% of losses are conducted to coolant, 2% to ambient air.

<sup>6)</sup> Depending on the number of modules, diode supply units can be configured as 6/12/24 -pulse solutions.

# Ratings, types and voltages

## Stand-alone liquid cooling unit, ACS880-1007LC

### Range 380 to 690 V

Liquid cooling unit type	Nominal ratings			Noise level	Losses				Internal flow <sup>1)</sup>	External flow <sup>2)</sup>
	P <sub>max</sub> [BTU(kW)]	Internal coolant volume	External coolant volume		P <sub>loss total</sub> [BTU(kW)]	P <sub>loss coolant</sub> [BTU(kW)]	P <sub>loss air</sub> [BTU(kW)]	P <sub>drop</sub> [PSI(kPa)]		
		[G(l)]	[G(l)]							
ACS880-1007LC-0070 <sup>3)</sup>	238850(70)	4.5(17)	0.8(3)	55	1365(0.4)	1024(0.3)	341(0.1)	22(150)	21(81) 82(310)	32(120)
ACS880-1007LC-0195+C140 <sup>3)</sup> /C141 <sup>4)</sup>	665368(195)	8.2(31) 9.2(35)	2.1(8)	55	4436(1.3)	3412(1.0)	1024(0.3)	22(150)	71(270) 94(355)	124(467)
ACS880-1007LC-0195+C213 <sup>5)</sup>	665368(195)	9.2(35)	2.1(8)	57	7165(2.1)	6142(1.8)	1024(0.3)	22(150)	82(310) 110(415)	124(467)

<sup>1)</sup> 17.4 PSI (120 kPa), Antifrogen® L 25%, 40 °C, 50/60 Hz

<sup>2)</sup> 36 °C water

<sup>3)</sup> Single pump

<sup>4)</sup> Redundant, one pump running at a time

<sup>5)</sup> Two pumps running

### Nominal ratings

P <sub>MAX</sub>	Maximum nominal cooling power
Internal flow	Nominal coolant flow rate from the liquid cooling unit to the drive modules
External flow	Nominal coolant flow rate to the liquid cooling unit from an external cooling circuit

### Losses

P <sub>loss total</sub>	Power loss conducted to coolant and emitted to air
P <sub>loss coolant</sub>	Power loss conducted to coolant
P <sub>loss air</sub>	Power loss emitted to air (ambient room)
P <sub>drop</sub>	Pressure loss in external cooling unit



# Ratings, types and voltages

## DC/DC converter, liquid-cooled, ACS880-1604LC

$U_N = 690$  V (range 525 to 690 V). The power ratings are valid at nominal voltage 690 V.

Converter type	Frame size	Filter type	No overload use				Short time overload cycle (10 s/60 s)		Heavy overload cycle (1 min/5 min)		Noise level	Losses	Coolant flow rate <sup>1)</sup>	
			$I_{dc}$ input DC [A]	$I_{rms}$ output DC [A]	$P_{contmax}$ [kW]	$I_{max}$ output DC [A]	$I_{p2p}$ [A]	$I_{short\ time}$ [A]	$P_{short\ time}$ [kW]	$I_{Hd}$ [A]				$P_{Hd}$ [kW]
ACS880-1604LC-0400A-7	R8i	BDCL-14LC-7	391	400	351	500	38	250	219	302	266	TBD	14331(4.2)	9.5(36)
ACS880-1604LC-0500A-7	R8i	BDCL-14LC-7	490	500	439	625	38	312	274	378	332	TBD	18084(5.3)	9.5(36)
ACS880-1604LC-0600A-7	R8i	BDCL-15LC-7	590	600	527	750	56	375	329	453	398	TBD	21155(6.2)	9.5(36)
ACS880-1604LC-0700A-7	R8i	BDCL-15LC-7	690	700	615	875	56	437	384	529	465	TBD	24909(7.3)	9.5(36)
ACS880-1604LC-0800A-7	R8i	BDCL-15LC-7	790	800	703	1000	56	500	439	605	531	TBD	29003(8.5)	9.5(36)
ACS880-1604LC-0900A-7	R8i	BDCL-15LC-7	880	900	790	1125	56	562	494	680	597	TBD	33098(9.7)	9.5(36)
ACS880-1604LC-1000A-7	2xR8i	2xBDCL-14LC-7	980	1000	878	1250	19	625	549	756	664	TBD	38216(11.2)	19(72)
ACS880-1604LC-1200A-7	2xR8i	2xBDCL-15LC-7	1180	1200	1054	1500	28	750	658	907	797	TBD	46405(13.6)	19(72)
ACS880-1604LC-1400A-7	2xR8i	2xBDCL-15LC-7	1370	1400	1230	1750	28	874	768	1058	929	TBD	55618(16.3)	19(72)
ACS880-1604LC-1600A-7	2xR8i	2xBDCL-15LC-7	1570	1600	1405	2000	28	999	878	1209	1062	TBD	64831(19.0)	19(72)
ACS880-1604LC-1800A-7	2xR8i	2xBDCL-15LC-7	1760	1800	1581	2250	28	1124	987	1360	1195	TBD	75067(22.0)	19(72)

<sup>1)</sup> Coolant flow rate for the whole converter unit (DC/DC converter module and filter).

### Ratings

#### No overload use

$I_{dc}$ input	Maximum continuous input DC current from DC bus
$I_{rms}$ output	Maximum continuous output current to/from energy storage
$P_{contmax}$	Maximum continuous output power to/from energy storage
$I_{max}$ output	Maximum instantaneous output current to/from energy storage
$I_{p2p}$	Maximum output ripple current to/from energy storage

#### Short time / heavy overload cycle

$I_{short\ time}$	Continuous output current allowing 10 s of $I_{MAX}$ (DC) every 60 seconds
$P_{short\ time}$	Continuous output power allowing 10 s of $I_{MAX}$ (DC) every 60 seconds
$I_{Hd}$	Continuous output current allowing overload of 150% $I_{hd}$ for 1 min every 5 min
$P_{Hd}$	Continuous output power allowing 150% $I_{hd}$ for 1 min every 5 min

#### Losses

$P_{loss}$	Power loss conducted to coolant and emitted to air
------------	--

# Dimensions

## ACS880 drive modules

### ACS880-01+P940, UL (NEMA) Type Open(IP20)

Frame size	Height [in(mm)]	Width [in(mm)]	Depth		Weight	
			+P940 [in(mm)]	+P944 [in(mm)]	+P940 [lb(kg)]	+P944 [lb(kg)]
R1	14.80(376) <sup>1)</sup>	6.10(155)	8.90(226)	8.90(226)	13(6.1)	14(6.5)
R2	14.80(376) <sup>1)</sup>	6.10(155)	9.80(249)	9.80(249)	17(7.5)	17(7.9)
R3	17.17(436) <sup>1)</sup>	6.81(173)	10.28(261)	10.28(261)	21(9.6)	22(10.1)
R4	22.17(563) <sup>1)</sup>	7.99(203)	13.11(333)	10.79(274)	38(17.1)	39(17.8)
R5	25.71(653) <sup>1)</sup>	7.99(203)	13.11(333)	10.79(274)	45(20.5)	47(21.4)
R6	23.35(593)	9.92(252)	14.06(357)	14.06(357)	85(38.7)	87(39.5)
R7	25.39(645)	11.18(284)	14.37(365)	14.37(365)	106(48)	108(49)
R8	28.50(724)	11.81(300)	15.20(386)	15.20(386)	134(61)	137(62)
R9	28.46(723)	14.96(380)	16.26(413)	16.26(413)	190(86)	192(87)

<sup>1)</sup> Comes with main power clamp.

### ACS880-04, UL (NEMA) Type Open(IP20/IP00)

Frame size	Height <sup>2)</sup> [in(mm)]	Width <sup>2)</sup> [in(mm)]	Depth [in(mm)]	Weight [lb(kg)]
R10	60.67(1541)	13.78(350)	19.92(506)	355(161)
R11	68.54(1741)	13.78(350)	19.92(506)	439(199)

<sup>2)</sup> Without pedestal (+0H354) and without IP20 shrouds and full-size terminals (+0B051+0H371) height is 7.05 in (179 mm) less and width 1.77 in (45 mm) less. More information from hardware manual.

### ACS880-04XT, UL (NEMA) Type Open(IP00/IP20)

Frame size	Height <sup>3)</sup> [in(mm)]	Width <sup>3)</sup> [in(mm)]	Depth [in(mm)]	Weight <sup>3)</sup> [lb(kg)]
R10	57.56(1462)	12.01(305)	19.92(506)	344(156)
R11	65.43(1662)	12.01(305)	19.92(506)	428(194)

<sup>3)</sup> With option "IP20 shrouds for covering the input and motor cabling area" height is 3.15 in (80 mm) more, width is 1.78 in (45mm) more, and weight is 11 lbs (5 kg) more.

### ACS880-04F, UL (NEMA) Type Open(IP20) (backside UL Type 12(IP55))

Without IP shrouds (+0B051) and full size output bus bars (+0H371) but with flange.

Frame size	Height [in(mm)]	Width [in(mm)]	Depth [in(mm)]	Weight [lb(kg)]
R11	64.84(1647)	24.41(620)	15.94(405)	483(219)

### ACS880-04FXT, UL (NEMA) Type Open(IP00) (backside UL Type 12(IP55))

With flange and shrouds.

Frame size	Height [in(mm)]	Width [in(mm)]	Depth [in(mm)]	Weight [lb(kg)]
R11	68.23(1733)	24.41(620)	18.78(477)	494(224)

### ACS880-04 module packages nxR8i, UL (NEMA) Type Open(IP00)

Frame size	Height [in(mm)]	Width [in(mm)]	Depth [in(mm)]	Weight [lb(kg)]
R8i	55.00(1397)	9.45(240)	22.95(583)	276(125)
D7T	46.38(1178)	6.69(170)	16.42(417)	176(80)
D8T	55.00(1397)	9.45(240)	22.99(584)	397(180)

ACS880-01+P940

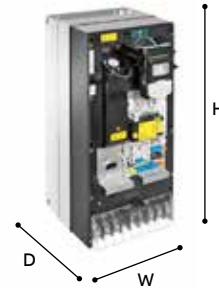

ACS880-01+P944



ACS880-04/04XT frame R11



ACS880-04F/04FXT frame R11



ACS880-04 frame R8i



ACS880-04 frame D8T

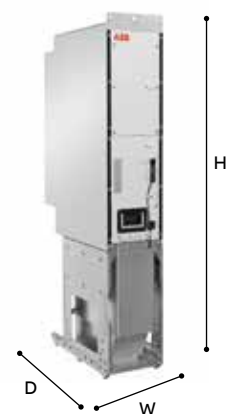

**ACS880-11/31+P940, UL (NEMA) Type Open(IP20)**

Frame size	Height [in(mm)]	Width [in(mm)]	Depth [in(mm)]	Weight [lb(kg)]
R3	19.29(490)	7.99(203)	13.74(349)	40(18.3)
R6	30.35(771)	9.92(252)	14.09(358)	130(59)
R8	37.99(965)	11.81(300)	16.93(430)	254(115) <sup>1)</sup>

<sup>1)</sup> 220 lb (100 kg) for 101A-5 and 124A-5.  
254 lb (115 kg) for 156A-5 and 180A-5.

**ACS880-14/34 frame R11, UL (NEMA) Type Open(IP20)**

Frame size	Height [in(mm)]	Width [in(mm)]	Depth [in(mm)]	Weight [lb(kg)]
R11	68.54(1741)	28.07(713)	20.16(512)	805(365)

**ACS880-14/34 module packages, UL (NEMA) Type Open(IP00)**

Frame size	Height [in(mm)]	Width [in(mm)]	Depth [in(mm)]	Weight [lb(kg)]
<b>Multidrive module</b>				
R8i	55.00(1397)	9.45(240)	22.95(583)	276(125)
<b>LCL line filter</b>				
BLCL-13-5	55.00(1397)	9.45(240)	19.88(505)	399(181)
BLCL-15-5	55.00(1397)	9.45(240)	19.88(505)	494(224)
BLCL-24-5	55.00(1397)	9.45(240)	22.87(581)	705(320)
BLCL-25-5	55.00(1397)	9.45(240)	22.87(581)	714(324)
BLCL-13-7	55.00(1397)	9.45(240)	19.88(505)	392(178)
BLCL-15-7	55.00(1397)	9.45(240)	19.88(505)	478(217)
BLCL-24-7	55.00(1397)	9.45(240)	22.87(581)	664(301)
BLCL-25-7	55.00(1397)	9.45(240)	22.87(581)	683(310)

**ACS880-104, air-cooled inverter unit (INU), UL (NEMA) Type Open(IP20 for frames R1i to R5i, IP00 for frames R6i to R8i)**

Frame size	Height [in(mm)]	Width [in(mm)]	Depth [in(mm)]	Weight [lb(kg)]
R1i	14.33(364)	3.54(90)	9.21(234)	7(3)
R2i	14.96(380)	3.94(100)	12.28(312)	11(5)
R3i	18.39(467)	6.61(168)	12.32(313)	22(10)
R4i	18.39(467)	8.78(223)	12.32(313)	37(17)
R5i	23.46(596)	7.99(203)	9.45(240)	31(14)
R6i	35.04(890)	6.69(170)	17.95(456)	84(38)
R7i	35.04(890)	6.69(170)	17.95(456)	86(39)
R8i	55.00(1397)	9.45(240)	22.95(583)	276(125)

ACS880-11/31+P940

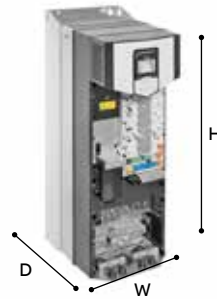

ACS880-14/34 R11

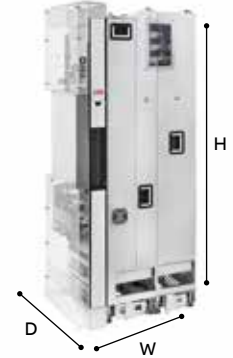

ACS880-14/34 frame R8i



BLCL filter



ACS880-104 frame R6i



ACS880-104 frame R8i

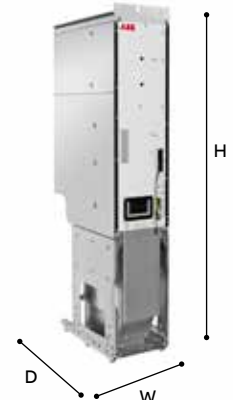

# Dimensions

## ACS880 drive modules

**ACS880-204, air-cooled IGBT supply unit (ISU),  
UL (NEMA) Type Open(IP20 for frames R1i to R4i, IP00 for  
frames R6i and R8i**

Frame size	Height [in(mm)]	Width [in(mm)]	Depth [in(mm)]	Weight [lb(kg)]
<b>Multidrive module</b>				
R1i	14.33(364)	3.54(90)	9.21(234)	9(4)
R2i	14.96(380)	3.94(100)	12.28(312)	13(6)
R3i	18.39(467)	6.50(165)	12.32(313)	24(11)
R4i	18.39(467)	8.66(220)	12.32(313)	40(18)
R6i	35.43(900)	6.69(170)	17.95(456)	84(38)
R8i	55.00(1397)	9.45(240)	22.95(583)	276(125)
<b>LCL line filter</b>				
WFU-01	12.4(315)	8.39(213)	8.58(218)	24(11)
WFU-02	12.4(315)	8.39(213)	8.58(218)	24(11)
WFU-11	15.2(386)	11.34(288)	10.08(256)	75(34)
WFU-21	15.98(406)	12.52(318)	11.77(299)	99(45)
WFU-22	15.98(406)	12.52(318)	11.77(299)	112(51)
ALCL-05-5	33.27(845)	14.88(378)	12.01(305)	220(100)
BLCL-13-5	55.00(1397)	9.45(240)	19.88(505)	399(181)
BLCL-15-5	55.00(1397)	9.45(240)	19.88(505)	494(224)
BLCL-24-5	55.00(1397)	9.45(240)	22.87(581)	705(320)
BLCL-25-5	55.00(1397)	9.45(240)	22.87(581)	714(324)
BLCL-13-7	55.00(1397)	9.45(240)	19.88(505)	392(178)
BLCL-15-7	55.00(1397)	9.45(240)	19.88(505)	481(218)
BLCL-24-7	55.00(1397)	9.45(240)	22.87(581)	664(301)
BLCL-25-7	55.00(1397)	9.45(240)	22.87(581)	683(310)

**ACS880-304, air-cooled diode supply modules (DSU),  
UL (NEMA) Type Open(IP00)**

Frame size	Height [in(mm)]	Width [in(mm)]	Depth [in(mm)]	Weight [lb(kg)]
D6D	32.09(815)	6.69(170)	16.34(415)	82(37)
D7D	41.50(1054)	6.69(170)	16.42(417)	161(73)
D8D	55.00(1397)	9.45(240)	23.19(589)	381(173)
D7T	46.38(1178)	6.69(170)	16.42(417)	176(80)
D8T	55.00(1397)	9.45(240)	23.19(589)	397(180)

ACS880-204 frame R8i



BLCL filter



ACS880-304 frame D8T



**ACS880-904, air-cooled regenerative rectifier unit (RRU), UL (NEMA) Type Open(IP00)**

Frame size	Height [in(mm)]	Width [in(mm)]	Depth [in(mm)]	Weight [lb(kg)]
<b>Multidrive module</b>				
R8i	55.00(1397)	9.45(240)	22.95(583)	276(125)
<b>L filter</b>				
BL-15-5	55.00(1397)	9.45(240)	17.48(444)	342(155)
BL-25-5	55.00(1397)	9.45(240)	21.61(549)	474(215)
BL-15-7	55.00(1397)	9.45(240)	17.48(444)	342(155)
BL-25-7	55.00(1397)	9.45(240)	21.61(549)	474(215)

ACS880-904 frame R8i



L filter



**ACS880-1604, DC/DC converter, UL (NEMA) Type Open(IP00)**

Frame size	Height [in(mm)]	Width [in(mm)]	Depth [in(mm)]	Weight [lb(kg)]
<b>Multidrive module</b>				
R8i	55.00(1397)	9.45(240)	22.95(583)	276(125)
<b>DCL filter</b>				
BDCL-14-5	55.00(1397)	9.45(240)	17.48(444)	430(195)
BDCL-14-7	55.00(1397)	9.45(240)	17.48(444)	430(195)
BDCL-15-5	55.00(1397)	9.45(240)	17.48(444)	496(225)
BDCL-15-7	55.00(1397)	9.45(240)	17.48(444)	496(225)

ACS880-1604 frame R8i



BDCL

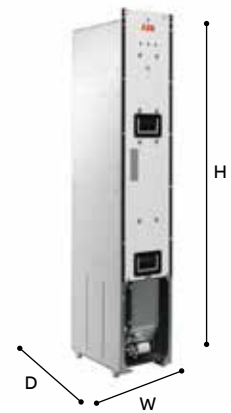

**ACS880-104LC, liquid-cooled inverter unit [inU], UL (NEMA) Type Open(IP00)**

Frame size	Height [in(mm)]	Width [in(mm)]	Depth [in(mm)]	Weight [lb(kg)]
R8i	34.65(880)	8.27(210)	19.17(487)	139(63) <sup>1</sup>

ACS880-104LC



**ACS880-304LC, liquid-cooled diode supply unit (DSU), UL (NEMA) Type Open(IP00)**

Frame size	Height [in(mm)]	Width [in(mm)]	Depth [in(mm)]	Weight [lb(kg)]
D8D	9.53(242)	6.69(170)	11.50(292)	26(12)

ACS880-304LC

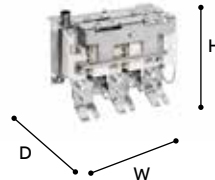

### ACS880-204LC, liquid-cooled IGBT supply unit (ISU), UL (NEMA) Type Open(IP00)

Frame size	Height [in(mm)]	Width [in(mm)]	Depth [in(mm)]	Weight [lb(kg)]
<b>Multidrive module</b>				
R8i	34.65(880)	8.27(210)	19.17(487)	139(63) <sup>1)</sup>
<b>LCL filter</b>				
<b>Grid-side choke</b>				
BLCL-15LC-7	17.60(447)	13.58(345)	14.53(369)	317(144)
BLCL-24LC-7	17.60(447)	13.58(345)	14.53(369)	322(146)
BLCL-25LC-7	18.82(478)	17.36(441)	14.96(380)	467(212)
<b>Converter-side choke</b>				
BLCL-15LC-7	17.68(449)	13.58(345)	14.88(378)	331(150)
BLCL-24LC-7	17.68(449)	13.58(345)	14.88(378)	326(148)
BLCL-25LC-7	18.78(477)	17.44(443)	15.20(386)	476(216)

<sup>1)</sup> For 0360A-7 to 0480A-7 the weight is 130 lb (59 kg).  
 For 0560A-7 to 0770A-7 the weight is 139 lb (63 kg).  
 For 0930A-7 the weight is 130 lb (59 kg) per module.  
 For 1090A-7 the weight is 139 lb (63 kg) per module.

ACS880-204LC



### ACS880-1604LC, liquid-cooled DC/DC converter, UL (NEMA) Type Open(IP00)

Frame size	Height [in(mm)]	Width [in(mm)]	Depth [in(mm)]	Weight [lb(kg)]
<b>Multidrive module</b>				
R8i	34.65(880)	8.27(210)	19.17(487)	139(63) <sup>1)</sup>
<b>DCL filter</b>				
BDCL-14LC-7	39.72(1009)	9.45(240)	17.91(455)	518(235)
BDCL-15LC-7	39.72(1009)	9.45(240)	17.91(455)	584(265)

<sup>1)</sup> For 0400A-7 and 0500A-7 the weight is 130 lb (59 kg).  
 For 0600A-7 to 0850A-7 the weight is 139 lb (63 kg).  
 For 1000A-7 the weight is 130 lb (59 kg) per module.  
 For 1200A-7 to 1800A-7 the weight is 139 lb (63 kg) per module.

ACS880-1604LC

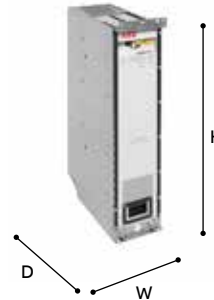

BDCL-15LC-7

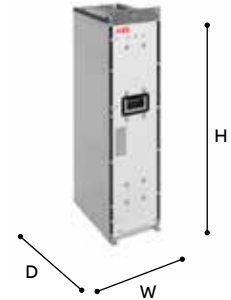

### ACS880-1007LC, liquid cooling unit, UL (NEMA) Type 12(IP54)

Frame size	Height [in(mm)]	Width [in(mm)]	Depth [in(mm)]	Weight [lb(kg)]
ACS880-1007LC-0070	78.82(2002)	12.99(330)	25.35(644)	441(200)
ACS880-1007LC-0195+C140	78.82(2002)	24.80(630)	25.35(644)	683(310)
ACS880-1007LC-0195+C141	78.82(2002)	24.80(630)	25.35(644)	807(366)
ACS880-1007LC-0195+C213	78.82(2002)	24.80(630)	25.35(644)	822(373)

ACS880-1007LC





# Standard interface and extensions for plug-in connectivity

—  
01 Control unit ZCU  
—  
02 Example of a typical drive modules input/output connection diagram. Variations may be possible. For further information, please see the ACS880 user manual.

ACS880 drive modules offer a wide range of standard interfaces including an extensive selection of I/O connections, Safe Torque Off (STO) and a galvanically isolated RS485 link that can be configured as either a Modbus RTU or a high speed drive-to-drive link.

In addition, the drive control unit (ZCU/BCU) has three option slots that can be used for: communication protocol adapters, input/output extension modules, feedback modules, and a safety functions module. For I/O extensions, see page 63.

The external control unit BCU-X2 is used with all parallel connected modules, including n×R8i, n×DxT, -04XT and 04FXT.



Control connections	Description
2 analog inputs (XAI)	Current input: -20 to 20 mA, $R_{in}$ : 100 ohm Voltage input: -10 to 10 V, $R_{in}$ > 200 kohm Resolution: 11 bit + sign bit
2 analog outputs (XAO)	0 to 20 mA, $R_{load}$ < 500 ohm Frequency range: 0 to 300 Hz Resolution: 11 bit + sign bit
6 digital inputs (XDI)	Input type: NPN/PNP (DI1 to DI5), NPN (DI6) DI6 (XDI:6) can alternatively be used as an input for a PTC thermistor.
Digital input interlock (DIIL)	Input type: NPN/PNP
2 digital inputs/outputs (XDIO)	As input: 24 V logic levels: "0" < 5 V, "1" > 15 V $R_{in}$ : 2.0 kohm Filtering: 0.25 ms As output: Total output current from 24 V DC is limited to 200 mA Can be set as pulse train input and output
3 relay outputs (XRO1, XRO2, XRO3)	250 V AC/30 V DC, 2 A
Safe torque off (XSTO)	For the drive to start, both connections must be closed
Drive-to-drive link (XD2D)	Physical layer: EIA-485
Built-in Modbus	EIA-485
Assistant control panel/PC tool connection	Connector: RJ-45

02

Relay outputs	XRO1, XRO2, XRO3	
Ready 250 V AC/30 V DC 2 A	NO	13
	COM	12
	NC	11
Running 250 V AC/30 V DC 2 A	NO	23
	COM	22
	NC	21
Faulted(-1) 250 V AC/30 V DC 2 A	NO	33
	COM	32
	NC	31
External power input	XPOW	
24 V DC, 2 A	GND	2
	+24Vl	1
Reference voltage and analog inputs	J1, J2, XAI	
AI1/AI2 current/voltage selection	AI1:U	AI2:U
	AI1:l	AI2:l
By default not in use. 0(4) to 20 mA, $R_{in} = 100 \text{ ohm}$	AI2-	7
	AI2+	6
Speed reference 0(2) to 10 V, $R_{in} > 200 \text{ kohm}$	AI1-	5
	AI1+	4
Ground	AGND	3
-10 V DC, $R_L 1 \text{ to } 10 \text{ kohm}$	-VREF	2
10 V DC, $R_L 1 \text{ to } 10 \text{ kohm}$	+VREF	1
Analog outputs	XAO	
Motor current 0 to 20 mA, $R_L < 500 \text{ ohm}$	AGND	4
	AO2	3
Motor speed rpm 0 to 20 mA, $R_L < 500 \text{ ohm}$	AGND	2
	AO1	1
Drive-to-drive link	J3, XD2D	
Drive-to-drive link termination	ON <input type="checkbox"/>	OFF
	Shield	4
Drive-to-drive link or built-in Modbus	BGND	3
	A	2
	B	1
Safe torque off	XSTO	
Safe torque off. Both circuits must be closed for the drive to start.	IN2	4
	IN1	3
	SGND	2
	OUT	1
Digital inputs	XDI	
By default not in use	DI6	6
Constant speed 1 select (1=on)	DI5	5
Acceleration and deceleration select	DI4	4
Reset	DI3	3
Forward (0)/Reverse (1)	DI2	2
Stop (0)/Start (1)	DI1	1
Digital input/outputs	XDIO	
Output: Running	DIO2	2
Output: Ready	DIO1	1
Ground selection	XD24	
Auxiliary voltage output, digital input interlock	DIOGND	5
Digital input/output ground	+24VD	4
+24 V DC 200 mA	DICOM	3
Digital input ground	+24VD	2
+24 V DC 200 mA	DIIl	1
Digital interlock		
Safety functions module connection	X12	
Control panel/PC connection	X13	
Memory unit connection	X205	

# Control panel options

—  
01 Bluetooth assistant control panel, ACS-AP-W

—  
02 Industrial assistant control panel without Bluetooth, ACS-AP-I

—  
03 Control panel mounting platform DPMP-01

—  
04 Control panel mounting platform DPMP-02

## Standard \*) Bluetooth assistant control panel, ACS-AP-W and Industrial assistant control panel, ACS-AP-I

The assistant control panel with a clear multilingual graphical display can be used for parameter setting and back-up, drive monitoring and operation, fault tracing and as a USB link for a PC tool. There are two different assistant control panels – with Bluetooth (ACS-AP-W) or without (ACS-AP-I). The panels can be mounted either on the drive or on the door of the enclosure and they are compatible with any ABB all-compatible drive.

The control panel helps you to set up the essential settings quickly and get the drive into action. To aid in troubleshooting, the control panel includes an event history, with clear text messages and real-time stamp.

The Bluetooth connection enables the use of mobile apps like Drivetune. This app is available for free on the Google Play and the Apple App store. Drivetune features include: commissioning, troubleshooting, monitoring and controlling the drive remotely. Drivetune also has full parameter access and backup and restore functionality.

**Control panel mounting platform, DPMP-01,** is for flush mountings and has UL(NEMA) Type 12 / IP54 protection class. It supports daisy chaining of the control panel link.

**Control panel mounting platform, DPMP-02,** is for surface mounting and has UL (NEMA) Type 12 / IP65 protection class (UL (NEMA) Type Open / IP20, when control panel not mounted).



## Control panel options

Option code	Ordering code for loose item	Description	Type
+0J400 <sup>1)</sup>	–	No control panel	–
–	ACS-AP-W	Bluetooth Assistant control panel. *) Included as standard for ACS880-01/11/31 and ACS880-04/04F up to frame size R11.	ACS-AP-W
+J425 <sup>1)</sup>	ACS-AP-I	Industrial assistant control panel without Bluetooth connection	ACS-AP-I
–	DPMP-01	Control panel mounting platform, flush mounted, UL (NEMA) Type 12 / IP54 (does not include control panel)	DPMP-01
–	DPMP-02	Control panel mounting platform, surface mounted, UL (NEMA) Type 12 / IP65 (does not include control panel)	DPMP-02

<sup>1)</sup> Plus codes are valid for ACS880-01/11/31/04/04F and -14/34 frame R11.

# Save time, ease troubleshooting and improve drive performance with ABB smartphone apps

## Better connectivity and user experience with Drivetune

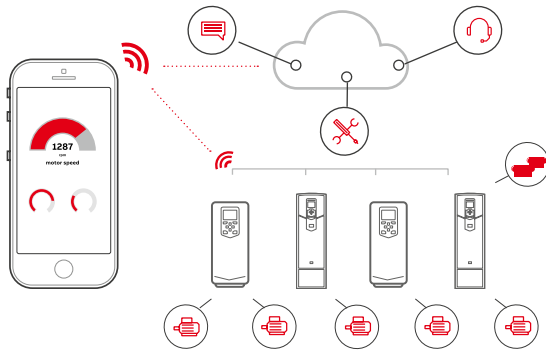

Easy and fast access to product information and support

## Manage your drives and the process lines and machines they control



Easy access to cloud-based drive and process information from anywhere via an online connection

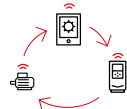

Start up, commission and tune your drive and application



Simplified user guidance with instant access to drive status and configuration



Performance optimization via drive troubleshooting features and fast support

## Services and support on the go with Drivebase

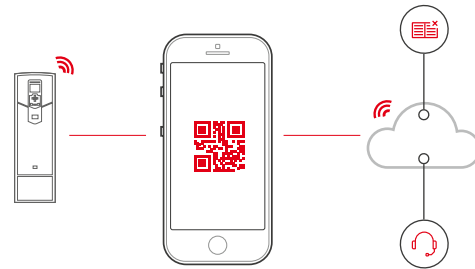

Search for support documents and contacts

## Maintain and service all your installed drives on one or multiple sites



Get 6 months extra warranty for free by registering your drive with the Drivebase app



Access your product and service information in the cloud from anywhere



Access your drive's diagnostics data



Push notifications for critical product and service updates

## Access information anywhere

Download the apps using the QR codes below or directly from the app stores



# Connectivity to automation systems

—  
01 ACS880 is compatible with many communication protocols

—  
02 Input/output extension modules

## Communication protocol adapters

ACS880 industrial drives are compatible with a wide range of communication protocols. The drive comes with a Modbus RTU fieldbus interface as standard.

The ACS880 supports two different communication connections simultaneously and offers the possibility for redundant communication. PROFIsafe (functional safety over PROFINET) is also supported.

### Communication protocol adapters

Option code <sup>1)</sup>	Ordering code for loose item	Communication protocol	Adapter
+K451	FDNA-01-KIT	DeviceNet™	FDNA-01
+K454	FPBA-01-KIT	PROFIBUS DP, DPV0/DPV1	FPBA-01
+K457	FCAN-01-KIT	CANopen®	FCAN-01
+K458	FSCA-01-KIT	Modbus RTU	FSCA-01
+K462	FCNA-01-KIT	ControlNet	FCNA-01
+K469	FECA-01-KIT	EtherCAT®	FECA-01
+K470	FEPL-01-KIT	POWERLINK	FEPL-02
+K475	FENA-21-KIT	Two port EtherNet/IP™, Modbus TCP, PROFINET IO, PROFIsafe <sup>2)</sup>	FENA-21
+K491	FMBT-21-KIT	Modbus/TCP	FMBT-21
+K492	FPNO-21-KIT	PROFINET IO	FPNO-21
+K490	FEIP-21-KIT	EtherNet/IP	FEIP-21
+Q986	3AXD50000112821	PROFIsafe safety functions module	FSPS-21

<sup>1)</sup> Plus codes are valid for ACS880-01/11/31/04/04F and -14/34 frame R11.

<sup>2)</sup> For the PROFIsafe to work the PROFINET fieldbus adapter module (FENA-21) and the safety functions module FSO-12 (+Q973) or FSO-21 (+Q972) are required.



01



02

## Input/output extension modules

Standard input and output can be extended by using optional analog and digital input/output extension modules. The modules are easily installed in the option slots located on the drive.

If there are not enough I/O extension slots in the drive, the FEA-03 module can increase the number of slots. The FEA-03 has two option slots for digital I/O extensions and speed feedback interface modules. The connection to the control unit is via an optical fiber link, and the adapter can be mounted on a DIN rail (35 × 7.5 mm).

### Analog and digital input/output extension modules

Option code <sup>1)</sup>	Ordering code for loose item	Description	I/O module
+L501	FIO-01	4×DI/O, 2×RO	FIO-01
+L500	FIO-11	3×AI (mA/V), 1×AO (mA), 2×DI/O	FIO-11
+L515	FEA-03	2×F-type option extension slots	FEA-03
+L525	FAIO-01	2×AI (mA/V), 2×AO (mA)	FAIO-01
+L526	FDIO-01	3×DI (up to 250 V DC or 230 V AC), 2×RO	FDIO-01

<sup>1)</sup> Plus codes are valid for ACS880-01/11/31/04/04F and -14/34 frame R11.

# Feedback interface and DDCS communication options

03 FEN-01 TTL encoder interface module

04 FDCO-01 DDCS communication module

## Speed feedback interfaces for precise process control

ACS880 drives can be connected to various feedback devices, such as HTL pulse encoders, TTL pulse encoders, absolute encoders and resolvers. The optional feedback module is installed in the option slot on the drive. It is possible to use two feedback modules at the same time, either of the same type or different types<sup>\*)</sup>.

<sup>\*)</sup> Excluding FSE-31.

03



## Feedback interface modules

Option code <sup>1)</sup>	Ordering code for loose item	Description	Feedback module
+L517	FEN-01	2 inputs (TTL pulse encoder), 1 output	FEN-01
+L518	FEN-11	2 inputs (SinCos absolute, TTL pulse encoder), 1 output	FEN-11
+L516	FEN-21	2 inputs (Resolver, TTL pulse encoder), 1 output	FEN-21
+L502	FEN-31	1 input (HTL pulse encoder), 1 output	FEN-31
+L521	FSE-31	Pulse encoder interface for functional safety (for more details see section "Safety options")	FSE-31

## DDCS communication option modules

The FDCO-0x optical DDCS communication options are add-on modules on the ACS880 industrial drives control unit. The modules include connectors for two fiber optic DDCS channels. The FDCO-0x modules make it possible to perform master-follower and AC800 M communication. An alternate way to perform master-follower communication is to use the standard RS485 connection.

04



## Optical communication modules

Option code <sup>1)</sup>	Ordering code for loose item	Description	Module
+L503	FDCO-01	Optical DDCS (10 Mbd/10 Mbd)	FDCO-01
+L508	FDCO-02	Optical DDCS (5 Mbd/10 Mbd)	FDCO-02

<sup>1)</sup> Plus codes are valid for ACS880-01/11/31/04/04F and -14/34 frame R11.



# Remote monitoring options

- 01 Remote monitoring tool NETA-21
- 02 RMDE reliability monitoring device

## Remote monitoring access worldwide

The NETA-21 remote monitoring tool gives easy access to the drive via the Internet or a local Ethernet network. NETA-21 comes with a built-in web server, that is compatible with standard web browsers, and ensures easy access to a web-based user interface. Through the web interface, the user can configure drive parameters, and monitor drive log data, load levels, runtime, energy consumption, I/O data, and motor bearing temperatures connected to the drive. One NETA-21 supports up to 10 ABB single drives.



01

## RMDE reliability monitoring device

The RMDE reliability monitoring device collects drive performance and event data so that it can be stored remotely and utilized for service, maintenance and troubleshooting. RMDE consists of the NETA-21 remote monitoring tool, a modem, and environmental sensors that enable collection of measured ambient temperature and humidity values. The device comes in a compact UL (NEMA) Type 12 / IP54 enclosure, making it suitable even for harsh environments.

## Remote monitoring option

Ordering code	Description	Type
3AUA0000094517	2 x panel bus interface max. 10 drives 2 x Ethernet interface SD memory card USB port for WLAN/3G	NETA-21



02

## RMDE reliability monitoring device

Ordering code	Description	Type
RMDE-01-1-1	RMDE reliability monitoring device	RMDE-01
Configurable product		

# PC tool options

—  
03 Drive Composer  
PC tool

—  
04 Automation Builder  
PC tool

## PC tools

The **Drive Composer** PC tool offers fast and harmonized setup, commissioning and monitoring for ABB's all-compatible drives.

The free version of the tool, **Drive Composer Entry**, provides startup and maintenance capabilities, and includes support for adaptive programming. It also gathers all drive information, such as parameter loggers, faults, backups and event lists, into a support diagnostics file.

**Drive Composer Pro** provides additional features, such as

- graphical reference and control chain diagrams
- possibility to connect to several drives simultaneously over Ethernet
- graphical interface for configuring functional safety features.

**Automation Builder** can be used as an alternative configuration tool to Drive Composer. It is a common tool for several ABB automation products, such as drives, PLCs, HMIs and robots.

For customized solutions, drive application programming based on IEC61131 standard is available for full PLC programmability with the **Drive Application Builder** tool.



—  
03



—  
04

## PC tools

Ordering code	Description	PC tool
DCPT-01-KIT	PC tool for setup, commissioning and monitoring of drives	Drive Composer Pro
3AXD50000342389	Standard version of the Drive Application Builder for IEC 61131-3 programming, DABS-STANDARD	
3AXD50000342402	Premium version of the Drive Application Builder for IEC 61131-3 programming, DABP-PREMIUM	licenses for Drive Application Builder <sup>1)</sup>
3AXD50000343027	Software development productivity add-ons for Drive Application Builder, version control and static analysis extensions for improve software engineering productivity, single workstation, DABX-PRODUCTIVITY-ADD-ONS	
1SAS010000R0102	Automation Builder 2.x Standard (2). Integrated engineering for PLC, drives, motion, SCADA and panels.	
1SAS010002R0102	Automation Builder 2.x Premium (5). Integrated Engineering and features for engineering productivity and collaboration.	Automation Builder
+N8010	License key for drive application programming based on IEC 61131-3 using Drive Application Builder	IEC programming

<sup>1)</sup> For IEC programming license key is needed for the ACS880 drive (+N8010)

# Safety options

—  
01 ACS880 drive  
with FSO-21, FSE-  
31 and FENA-21

## Integrated safety

Integrated safety reduces the need for external safety components, simplifying configuration and reducing installation space. The safety functionality is a built-in feature of the ACS880, with Safe Torque Off (STO) as standard. The STO function corresponds to an uncontrolled stop in accordance with stop category 0 of EN 60204-1. Additional safety functions can be commissioned with the optional and compact safety functions module. ACS880 drives offer functional safety with or without encoder. The drive's functional safety is designed in accordance with EN/IEC 61800-5-2 and complies with the requirements of the European Union Machinery Directive (2006/42/EC).

The safety functions are certified by TÜV Nord and comply with the highest performance requirements (SIL 3/PL e) in machinery safety. <sup>1)</sup>

The safety functions module can also be ordered separately and installed afterwards on the drive.

PROFIsafe safety functions module, FSPS-21, with integrated PROFIsafe, and PROFINET IO connection supports STO and SS1-t safety functions. Since the functions are automatically configured, no additional safety settings are required in the drive.

Safety functions modules, FSO-12 and FSO-21, support a wide range of safety functions. Configuration of the functions is done with the Drive Composer Pro PC tool, which provides an easy-to-use graphical user interface. Larger safety systems can be built using PROFIsafe over PROFINET connection between a safety PLC (such as AC500-S) and the ACS880 drive.

## Safety function modules

Option code <sup>2)</sup>	Ordering code for loose item	Description	Safety module
+Q973	FSO-12 KIT	Safety functions module FSO-12	FSO-12
+Q972+L521	FSO-21 KIT FSE-31	Safety functions module FSO-21 and encoder FSE-31	FSO-21+FSE-31
+Q971 <sup>4)</sup>	–	ATEX-certified safe disconnection function, EX II (2) GD	
+Q982	–	PROFIsafe safety communication to be used together with FSO-12 or FSO-21: forces to select a functional safety module and PROFINET adapter, FPNO-21	FSO-12 or FSO-21 +FPNO-21
+Q986 <sup>3)</sup>	3AXD50000112821	PROFIsafe safety functions module FSPS-21	FSPS-21
+L536	FPTC-01	Thermistor protection module FPTC-01	FPTC-01
+L537 <sup>4)</sup>	3AXD50000024924	ATEX-certified thermistor protection module FPTC-02 , Ex II (2) GD	FPTC-02

<sup>1)</sup> Thermistor modules comply with SIL 2 / PL c.

<sup>2)</sup> Plus codes are valid for ACS880-01/11/31/04/04F and -14/34 frame R11.

<sup>3)</sup> Please contact your local ABB office to check availability.

<sup>4)</sup> These products are available but have an extended leave time. Contact your local ABB office for more details.



—  
01

The connection is achieved by adding a PROFINET adapter, FPNO-21, to the drive.

Supported safety functions:

- Without encoder: SS1-t, SS1-r, SLS, SBC, SMS, SSE, POUS, STO
- With encoder (requires FSO-21 + FSE-31): SDI, SSM, SS1-t, SS1-r, SLS, SBC, SMS, SSE, POUS, STO

## Pulse encoder interface module, FSE-31,

provides safe encoder data to the safety functions module, and can simultaneously be used as a feedback device for the drive. FSE-31 requires an FSO-21 safety functions module and supports HTL encoders.

## Thermistor protection modules, FPTC-01 and FPTC-02

Safe Temperature Monitoring (STM) can be achieved by using FPTC thermistor protection modules. <sup>1)</sup>

Safety function	Description	Supported functions			
		FSPS-21	F50-12 without encoder	F50-21 + F5E-31 + HTL encoder	
Safe stop 1 SS1-t SS1-r	Brings the machine to a stop using a monitored deceleration ramp. It is typically used in applications where the machinery motion needs to be brought to a stop (stop category 1) in a controlled way before switching over to the no-torque (STO) state	x (SS1-t)	x (SS1-t) x (SS1-r)	x (SS1-t) x (SS1-r)	
Safe stop emergency SSE	Can be configured to, upon request, either activate STO instantly (category 0 stop), or first initiate motor deceleration and then, once the motor has stopped, activate the STO (category 1 stop).		x	x	
Safe brake control SBC	Provides a safe output for controlling the motor's external (mechanical) brakes, together with STO.		x	x	
Safely-limited speed SLS	Ensures that the specified speed limit of the motor is not exceeded. This allows machine interaction to be performed at slow speed without stopping the drive. The safety function module comes with four individual SLS settings for speed monitoring.		x	x	
Safe maximum speed SMS	Monitors that the speed of the motor does not exceed the configured maximum speed limit.		x	x	
Prevention of unexpected start-up POUS	Ensures that the machine remains stopped when people are in the danger area.		x	x	
Safe direction SDI	Ensures that rotation is allowed only in the selected direction (available only with F50-21 and F5E-31).			x	
Safe speed monitor SSM	Provides a safe output signal to indicate whether the motor speed is between user-defined limits (available only with F50-21).			x	
Safe torque off STO	Brings the drive safely to a no-torque state, i.e. switches off the drive output to the motor, motor speed then coasts to a stop.  ACS880 has safe torque off as standard.	x	x	x	

# EMC – electromagnetic compatibility

—  
01 Immunity and  
emission compatibility

Each ACS880 model can be equipped with a built-in filter to reduce high-frequency emissions.

## EMC standards

The EMC product standard (EN 61800-3) covers the specific EMC requirements for drives (tested with motor and motor cable) within the EU. EMC standards such as EN 55011 or EN 61000-6-3/4 are applicable to industrial and domestic equipment and systems, including the components inside the drive. Drive units compliant with EN 61800-3 are also compliant with comparable categories in EN 55011 and EN 61000-6-3/4, but not necessarily vice versa. EN 55011 and EN 61000-6-3/4 do not specify cable length or require a motor to be connected as a load. The emission limits are comparable to EMC standards according to the table on the next page.

## Domestic environments versus public low voltage networks

The first environment includes domestic premises. It also includes establishments directly connected without an intermediate transformer to a low voltage power supply network that supplies buildings used for domestic purposes.

The second environment includes all establishments other than those directly connected to a low voltage power supply network that supplies buildings used for domestic purposes.

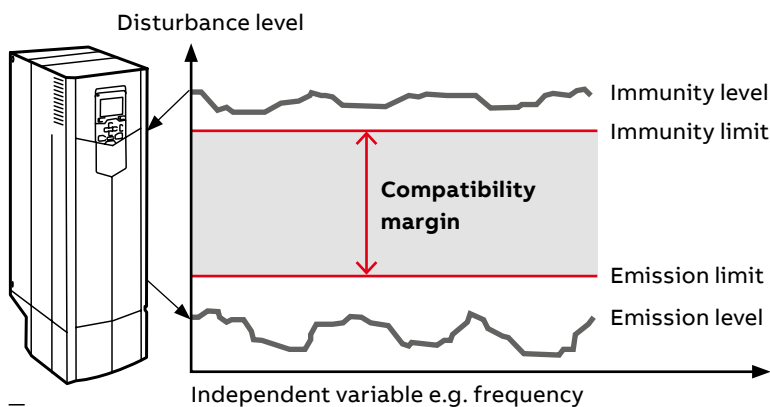

—  
01

## EMC standards

EMC according to EN 61800-3:2004 + A1:2012 product standard	EN 61800-3 product standard	EN 55011, product family standard for industrial, scientific and medical (ISM) equipment	EN 61000-6-4, generic emission standard for industrial environments	EN 61000-6-3, generic emission standard for residential, commercial and light-industrial environment
1 <sup>st</sup> environment, restricted distribution	Category C2	Group 1. Class A	Applicable	Not applicable
2 <sup>nd</sup> environment, unrestricted distribution	Category C3	Group 2. Class A	Not applicable	Not applicable
2 <sup>nd</sup> environment, restricted distribution	Category C4	Not applicable	Not applicable	Not applicable

## Selecting an EMC filter

Drive type	Voltage (V)	Frame sizes	1 <sup>st</sup> environment, restricted distribution, C2, grounded network (TN) Option code	2 <sup>nd</sup> environment, C3, grounded network (TN) Option code	2 <sup>nd</sup> environment, C3, ungrounded network (IT) Option code	2 <sup>nd</sup> environment, C4, grounded network (TN) <sup>4)</sup>	
ACS880-01	380 to 500	R1 to R9		+E202	+E200	+E201 <sup>1)</sup>	As standard
ACS880-01	525 to 690	R3 to R9		-	+E200	+E201 <sup>1)</sup>	As standard
ACS880-04	380 to 500	R10, R11		+E202	+E200	+E201	As standard
ACS880-04	525 to 690	R10, R11		-	+E200	+E201	As standard
ACS880-04	380 to 690	nxD8T+ n×R8i	Not for -7. Only for 1xD8T <sup>2)</sup>	As standard <sup>3)</sup>	As standard <sup>3)</sup>	As standard <sup>3)</sup>	As standard
ACS880-04F	380 to 690	R11		-	+E200	+E201	As standard
ACS880-04XT	380 to 500	2×R10/11		ARFI-10	+E200	+E201	As standard
ACS880-04XT	525 to 690	2×R10/11		-	+E200	+E201	As standard
ACS880-04FXT	380 to 500	n×R11		ARFI-10	+E200	+E201	As standard
ACS880-04FXT	525 to 690	n×R11		-	+E200	+E201	As standard
ACS880-11	380 to 500	R3 to R8	+E202 (not available for R6)	+E200	+E200	+E201	As standard
ACS880-31	380 to 500	R3 to R8	+E202 (not available for R6)	+E200	+E200	+E201	As standard
ACS880-14	380 to 690	R11		+E202	+E200	-	As standard
ACS880-14	380 to 690	n×R8i	Not for -7. Only for 1×R8i <sup>2)</sup>	As standard <sup>3)</sup>	As standard <sup>3)</sup>	As standard <sup>3)</sup>	As standard
ACS880-34	380 to 690	R11		+E202	+E200	-	As standard
ACS880-34	380 to 690	n×R8i	Not for -7. Only for 1×R8i <sup>2)</sup>	As standard <sup>3)</sup>	As standard <sup>3)</sup>	As standard <sup>3)</sup>	As standard
ACS880-104	380 to 690	R1 to n×R8i		-	As standard <sup>3)</sup>	As standard <sup>3)</sup>	As standard
ACS880-204	380 to 690	R1i to R4i, R6i, n×R8i	Not for -7. Only for sizes up to 1×R8i <sup>2)</sup>	As standard <sup>3)</sup>	As standard <sup>3)</sup>	As standard <sup>3)</sup>	As standard
ACS880-304	380 to 690	D×D, n×DXT	Not for -7. Only for 1xD8T <sup>2)</sup>	As standard <sup>3)</sup>	As standard <sup>3)</sup>	As standard <sup>3)</sup>	As standard
ACS880-104LC	525 to 690	n×R8i		-	As standard <sup>3)</sup>	As standard <sup>3)</sup>	As standard
ACS880-204LC	525 to 690	n×R8i		-	As standard <sup>3)</sup>	As standard <sup>3)</sup>	As standard
ACS880-304LC	525 to 690	n×D8D		-	As standard <sup>3)</sup>	As standard <sup>3)</sup>	As standard

<sup>1)</sup> 2<sup>nd</sup> environment, C4: ACS880-01, 380 to 500 V, frame sizes R1 to R5. ACS880-01, -7, frame sizes R3 to R6.

<sup>2)</sup> For Category C2 optional equipment is needed, and the drive must be installed according to the instructions given in the manuals.

<sup>3)</sup> For Category C3 no optional equipment is needed, but the drive must be installed according to the instructions given in the manuals.

<sup>4)</sup> For Category C4 no optional equipment is needed, but the drive must be installed according to the instructions given in the manuals.



---

# Sine filters

Together with a sine filter, ACS880 drives offer smooth motor operation in both DTC and scalar modes. The sine filter suppresses the high-frequency components of the motors output voltage, creating an almost a sinusoidal voltage wave form for the motor. The filter offers an optimized LC design that takes into account the switching frequency, voltage drop and filtering characteristics.

The ACS880 inverter and sine filter solution can be used together with a variety of requirements for products and components:

- For motors without adequate insulation for the role
- Where the total motor cable length is long as a result of a number of parallel motors
- For step-up applications, e.g. where a medium voltage motor needs to be driven
- For submersible pumps with long motor cables, e.g. in the oil industry
- When the motor noise needs to be reduced
- When there are industry-specific requirements for peak voltage level and voltage rise time

---

ABB recommends contacting a US filter company (MTE, TCI, etc) to select and order the compatible UL approved sine filter. Please contact your local ABB office for further information.

# Brake options

## Brake chopper

Brake chopper handles the energy generated by a decelerating motor. The chopper connects the brake resistor to the DC bus whenever the voltage in the bus exceeds the limit defined by the control program. Energy consumption by the resistor losses lowers the voltage until the resistor can be disconnected. For ACS880 the brake chopper is either built-in as standard or offered as an internal or external option.

## Brake resistor

The brake resistors should be sized per the application (duty cycle).

Please contact your local ABB office for further information.

Brake chopper			
ACS880 type (frame sizes)	Built-in as standard	Internal option	External option
-01 (R1 to R4)	X		
-01 (R5 to R9)		X	
-04/04F (R10, R11)		X	
-04XT (2×R10/11)		X	
-11/14/31/34 (R3 to R8, R11)			X *)
-04/14/34 (n×R8i)			X
-x04			X

\*) For more information, please contact your local ABB office.

## Brake options, ACS880-x04

$U_N = 500 \text{ V}$  (range 380 to 500V)

Brake chopper unit type	Brake chopper module type	Nominal ratings					Duty cycle (1min/5min)		Duty cycle (10s/60s)		Noise [db(A)]	Air flow [cfm(m <sup>3</sup> /h)]
		$P_{brmax}$ [kW]	$R_{min}$ [ohm]	$I_{max}$ [A]	$I_{rms}$ [A]	$P_{cont}$ [kW]	$P_{br}$ [kW]	$I_{rms}$ [A]	$P_{br}$ [kW]	$I_{rms}$ [A]		
<b>Brake chopper without brake resistor</b>												
ACS880-604-0260-5	NBRA658	268	2.15	380	101	81	268	331	268	331	64	388(660)
ACS880-604-0400-5	NBRA659	403	1.43	571	136	109	317	391	403	498	64	388(660)
ACS880-604-0800-5	2×NBRA659	806	0.72	1142	272	218	634	782	806	996	67	777(1320)
ACS880-604-1200-5	3×NBRA659	1208	0.48	1713	408	327	951	1173	1209	1494	68	1165(1980)
ACS880-604-1600-5	4×NBRA659	1611	0.36	2284	544	436	1268	1564	1612	1992	69	1554(2640)
ACS880-604-2000-5	5×NBRA659	2014	0.29	2855	680	545	1585	1955	2015	2490	70	1942(3300)
ACS880-604-2400-5	6×NBRA659	2417	0.24	3426	816	654	1902	2346	2418	2988	71	2331(3960)

$U_N = 690 \text{ V}$  (range 525 to 690 V)

Brake chopper unit type	Brake chopper module type	Nominal ratings					Duty cycle (1min/5min)		Duty cycle (10s/60s)		Noise [db(A)]	Air flow [cfm(m <sup>3</sup> /h)]
		$P_{brmax}$ [kW]	$R_{min}$ [ohm]	$I_{max}$ [A]	$I_{rms}$ [A]	$P_{cont}$ [kW]	$P_{br}$ [kW]	$I_{rms}$ [A]	$P_{br}$ [kW]	$I_{rms}$ [A]		
<b>Brake chopper without brake resistor</b>												
ACS880-604-0400-7	NBRA669	404	2.72	414	107	119	298	267	404	361	64	388(660)
ACS880-604-0800-7	2×NBRA669	807	1.36	828	214	238	596	534	808	722	64	388(660)
ACS880-604-1200-7	3×NBRA669	1211	0.91	1242	321	357	894	801	1212	1083	64	777(1320)
ACS880-604-1600-7	4×NBRA669	1615	0.68	1656	428	476	1192	1068	1616	1444	64	1165(1980)
ACS880-604-2000-7	5×NBRA669	2019	0.54	2070	535	595	1490	1335	2020	1805	64	1554(2640)
ACS880-604-2400-7	6×NBRA669	2422	0.45	2484	642	714	1788	1602	2424	2166	64	1942(3300)

### Ratings

$P_{brmax}$	Maximum short time braking power.
$R_{min}$	Minimum allowable resistance value for the brake resistor.
$P_{cont}$	Maximum continuous braking power. Continuous power (heat) dissipation of the resistor when placed correctly. Energy $E_r$ dissipates in 400 seconds.
$I_{MAX}$	Maximum peak current per chopper during braking. Current is achieved with recommended resistor resistance.
$I_{rms}$	Corresponding rms current per chopper during load cycle.
$P_{br}$	Braking power during corresponding duty cycle: 1 min/5 min = 1 minute braking with power $P_{br}$ and 4 minutes unload. 10 s/60 s = 10 second braking with power $P_{br}$ and 50 seconds unload.

### Dimensions for choppers

Frame size	Height	Width	Depth	Weight
	[in(mm)]	[in(mm)]	[in(mm)]	[lb(kg)]
NBRA658	22.99(584)	13.15(334)	9.45(240)	57(26)
NBRA659	22.99(584)	13.15(334)	9.45(240)	57(26)
NBRA669	22.99(584)	13.15(334)	9.45(240)	57(26)

## ACS880-604 3-phase dynamic brake units

$U_N = 500 \text{ V}$  (range 380 to 500 V)

Brake unit type	Frame size	Resistor values		Ratings $R_{min}$								Ratings $R_{max}$							
				No-overload use				Duty cycle (1min/5min)				No-overload use				Duty cycle (1min/5min)			
				$R_{min}$	$R_{max}$	$I_{dc}$	$I_{rms}$	$P_{rcont}$	$I_{max}$	$I_{dc}$	$I_{rms}$	$-R_{min}$	$P_{br}$	$-R_{min}$	$I_{dc}$	$I_{rms}$	$P_{contmax}$	$I_{max}$	$I_{dc}$
(ohm)	(ohm)	(A)	(A)	(kW)	(A)	(A)	(A)	(A)	(A)	(A)	(A)	(A)	(kW)	(A)	(A)	(A)	(A)	(kW)	
ACS880-604-0630-5	R8i	2.2	2.6	781	310	630	370	999	351	800	781	284	630	312	835	293	835	293	670
ACS880-604-0940-5	R8i	1.4	1.7	1171	465	940	555	1499	527	1210	1171	430	940	468	1277	449	1277	449	1030
ACS880-604-1260-5	2xR8i	2.2	2.6	1562	621	1260	740	1998	702	1610	1562	568	1260	625	1671	587	1671	587	1340
ACS880-604-1880-5	2xR8i	1.4	1.7	2342	931	1880	1110	2997	1053	2410	2342	860	1880	937	2555	898	2555	898	2060
ACS880-604-2830-5	3xR8i	1.4	1.7	3514	1396	2830	1665	4496	1580	3620	3514	1289	2830	1405	3832	1347	3832	1347	3080
ACS880-604-3770-5	4xR8i	1.4	1.7	4685	1862	3770	2220	5994	2106	4820	4685	1719	3770	1874	5110	1795	5110	1795	4110
ACS880-604-4710-5	5xR8i	1.4	1.7	5856	2327	4710	2775	7493	2633	6030	5856	2149	4710	2342	6387	2244	6387	2244	5140

$U_N = 690 \text{ V}$  (range 525 to 690 V)

Brake unit type	Frame size	Resistor values		Ratings $R_{min}$								Ratings $R_{max}$							
				No-overload use				Duty cycle (1min/5min)				No-overload use				Duty cycle (1min/5min)			
				$R_{min}$	$R_{max}$	$I_{dc}$	$I_{rms}$	$P_{rcont}$	$I_{max}$	$I_{dc}$	$-R_{min}$	$-R_{min}$	$I_{dc}$	$I_{rms}$	$P_{contmax}$	$I_{max}$	$I_{dc}$	$-R_{min}$	$-R_{max}$
(ohm)	(ohm)	(A)	(A)	(kW)	(A)	(A)	(A)	(kW)	(A)	(A)	(kW)	(A)	(A)	(A)	(kW)				
ACS880-604-0870-7	R8i	3.0	3.6	781	310	870	370	999	351	1110	781	283	870	312	833	293	920		
ACS880-604-1300-7	R8i	2.0	2.4	1171	465	1300	555	1499	527	1660	1171	425	1300	468	1249	439	1390		
ACS880-604-1730-7	2xR8i	3.0	3.6	1562	621	1730	740	1998	702	2220	1562	567	1730	625	1665	585	1850		
ACS880-604-2600-7	2xR8i	2.0	2.4	2342	931	2600	1110	2997	1053	3330	2342	850	2600	937	2498	878	2770		
ACS880-604-3900-7	3xR8i	2.0	2.4	3514	1396	3900	1665	4496	1580	4990	3514	1275	3900	1405	3746	1316	4160		
ACS880-604-5200-7	4xR8i	2.0	2.4	4685	1862	5200	2220	5994	2106	6650	4685	1700	5200	1874	4995	1755	5540		
ACS880-604-6500-7	5xR8i	2.0	2.4	5856	2327	6500	2775	7493	2633	8320	5856	2125	6500	2342	6244	2194	6930		

### Ratings

#### Resistor

$R_{min}$  Minimum allowed resistance value of the brake resistor for one phase of the brake module.

$R_{MAX}$  Resistance value of the brake resistor for one phase of the brake module corresponding to the maximum achieved continuous braking power.

Note: Connect one resistor per brake module phase. For example, a brake unit of frame size 2xR8i including two brake modules □ 2 x 3 resistors are needed.

#### Typical ratings for no-overload use

$I_{dc}$  Total input DC current of brake unit.

$I_{rms}$  Total rms DC output phase current of brake unit.

$I_{MAX}$  Peak brake current (DC) per chopper module phase.

$P_{cont,max}$  Maximum continuous braking power per brake unit.

#### Cyclic load (1 min/5 min)

$I_{dc}$  Total input DC current of brake unit during a period of 1 minute with braking power  $P_{br}$ .

$I_{rms}$  Total rms DC current per brake unit phase during a period of 1 minute with braking power  $P_{br}$ .

$P_{br}$  Short term braking power

### Dimensions

Frame size	Height [in(mm)]	Width [in(mm)]	Depth [in(mm)]	Weight [lb(kg)]
R8i	55.00(1397)	9.45(240)	22.95(583)	276(125)

## ACS880-604LC liquid cooled 1-phase brake units

$U_N = 690 \text{ V}$  (range 525 to 690 V)

Type	Module type	Nominal ratings				Duty cycle (1min/5min)		Duty cycle (10s/60s)		Losses		Coolant flow rate <sup>1)</sup> [GPM(l/ min)]	Air flow <sup>2)</sup> [cfm (m <sup>3</sup> /h)]
		$P_{brmax}$ [kW]	$R_{tot}$ [ohm]	$I_{max}$ [A]	$I_{rms}$ [A]	$P_{brcont}$ [kW]	$P_{br}$ [kW]	$I_{rms}$ [A]	$P_{br}$ [kW]	$I_{rms}$ [A]	$P_{loss}$ [BTU(kW)]		
<b>Brake chopper without brake resistor</b>													
ACS880-604LC-0400-7	NBRW-669C	404	-	414	107	119	298	267	404	361	6824(2)	0.4(1.6)	-
ACS880-604LC-0800-7	2xNBRW-669C	807	-	828	214	238	596	534	808	722	13649(4)	0.8(3.2)	-
ACS880-604LC-1200-7	3xNBRW-669C	1211	-	1242	321	357	894	801	1212	1083	20473(6)	1.3(4.8)	-
ACS880-604LC-1600-7	4xNBRW-669C	1615	-	1656	428	476	1192	1068	1616	1444	27297(8)	1.7(6.4)	-
ACS880-604LC-2000-7	5xNBRW-669C	2019	-	2070	535	595	1490	1335	2020	1805	34121(10)	2.1(8.0)	-
ACS880-604LC-2400-7	6xNBRW-669C	2422	-	2484	642	714	1788	1602	2424	2166	40946(12)	2.5(9.6)	-

### Dimensions

Type	Height [in(mm)]	Width [in(mm)]	Depth [in(mm)]	Weight [lb(kg)]
Brake chopper NBRW-669C	22.97(583.5)	12.83(326)	7.56(192)	64(29)

### Ratings

#### Nominal ratings

$P_{brmax}$	Maximum short-term (1 min every 10 mins) braking power.
$I_{MAX}$	Maximum peak current of the whole brake unit.
$I_{rms}$	Corresponding rms current per chopper during load cycle.
$P_{brcont}$	Maximum continuous power rating.

#### Cyclic load (1 min/5 min)

$P_{br}$	Maximum braking power, allowed for 1 minute every 5 minutes.
$I_{rms}$	Total rms current during a period of 1 minute with braking power $P_{br}$ .

#### Cyclic load (1 min/5 min)

$P_{br}$	Total rms current during a period of 10 seconds with braking power $P_{br}$ .
$I_{rms}$	Maximum braking power, allowed for 10 seconds every 60 seconds

#### Losses

$P_{loss}$	Power loss conducted to coolant and emitted to air.
------------	---



K



# Du/dt filters

Du/dt filtering suppresses inverter output voltage spikes and rapid voltage changes that stress motor insulation. Additionally, du/dt filtering reduces capacitive leakage currents and high-frequency emissions from the motor cable, as well as high-frequency losses and bearing currents in the motor. The need for du/dt filtering depends on the motor insulation. For information on the construction of the motor insulation, consult the manufacturer.

If the motor does not meet the following requirements, the lifetime of the motor might decrease. Insulated N-end (non-driven end) bearings and/or common mode filters are also required for motor bearing currents with motors bigger than 100 kW. For more information, please see the ACS880 hardware manuals.

Please see below for information about how to select a filter according to the motor.

## Filter selection table for ACS880

Motor type	Nominal AC supply voltage	Requirements for Motor insulation system	ABB du/dt and common mode filters, insulated N-end motor bearings		
			$P_N < 100 \text{ kW}$ and frame size < IEC 315	$100 \text{ kW} \leq P_N < 350 \text{ kW}$ or IEC 315 $\leq$ frame size < IEC 400	$P_N \geq 350 \text{ kW}$ or frame size $\geq$ IEC 400
			$P_N < 134 \text{ hp}$ and frame size < NEMA 500	$134 \text{ hp} \leq P_N < 469 \text{ hp}$ or NEMA 500 $\leq$ frame size $\leq$ NEMA 580	$P_N \geq 469 \text{ hp}$ or frame size $\geq$ NEMA 580
<b>ABB motors</b>					
Random-wound M2__, M3__ and M4__	$U_N \leq 500 \text{ V}$	Standard	–	+ N	+ N + CMF
	$500 \text{ V} < U_N \leq 600 \text{ V}$	Standard	+ du/dt	+ du/dt + N	+ du/dt + N + CMF
	$600 \text{ V} < U_N \leq 690 \text{ V}$ (cable length $\leq 150 \text{ m}$ )	Reinforced	–	+ N	+ N + CMF
		Reinforced	+ du/dt	+ du/dt + N	+ du/dt + N + CMF
Form-wound HX__ and AM__	$380 \text{ V} < U_N \leq 690 \text{ V}$	Standard	n/a	+ N + CMF	$P_N < 500 \text{ kW}$ : + N + CMF $P_N \geq 500 \text{ kW}$ : + du/dt + N + CMF
	$380 \text{ V} < U_N \leq 690 \text{ V}$	Check with the motor manufacturer	+ du/dt with voltages over 500 V + N + CMF	+ du/dt with voltages over 500 V + N + CMF	+ du/dt with voltages over 500 V + N + CMF
Random-wound HX__ and AM__ <sup>2)</sup>	$0 \text{ V} < U_N \leq 500 \text{ V}$	Enameled wire with fiber glass taping	+ N + CMF	+ N + CMF	+ N + CMF
	$500 \text{ V} < U_N \leq 690 \text{ V}$		+ du/dt + N + CMF	+ du/dt + N + CMF	+ du/dt + N + CMF
HPD	Consult the motor manufacturer.				
<sup>1)</sup> Manufactured before 1.1.1998. <sup>2)</sup> For motors manufactured before 1.1.1998, check for additional instructions with the motor manufacturer.					
<b>Non-ABB motors</b>					
Random-wound and form-wound	$U_N \leq 420 \text{ V}$	Standard: $\hat{U}_{LL} = 1300 \text{ V}$	–	+ N or CMF	+ N + CMF
		Standard: $\hat{U}_{LL} = 1300 \text{ V}$	+ du/dt	+ du/dt + N or + du/dt + CMF	+ du/dt + N + CMF
	$420 \text{ V} < U_N \leq 500 \text{ V}$	Reinforced: $\hat{U}_{LL} = 1600 \text{ V}$ , 0,2 microsecond rise time	–	+ N or CMF	+ N + CMF
		Reinforced: $\hat{U}_{LL} = 1600 \text{ V}$	+ du/dt	+ du/dt + N or + du/dt + CMF	+ du/dt + N + CMF
	$500 \text{ V} < U_N \leq 600 \text{ V}$	Reinforced: $\hat{U}_{LL} = 1800 \text{ V}$	–	+ N or CMF	+ N + CMF
		Reinforced: $\hat{U}_{LL} = 1800 \text{ V}$	+ du/dt	+ du/dt + N	+ du/dt + N + CMF
$600 \text{ V} < U_N \leq 690 \text{ V}$	Reinforced: $\hat{U}_{LL} = 2000 \text{ V}$ , 0,3 microsecond rise time <sup>3)</sup>	–	+ N + CMF	+ N + CMF	
	Reinforced: $\hat{U}_{LL} = 2000 \text{ V}$ , 0,3 microsecond rise time <sup>3)</sup>	+ du/dt	+ N + CMF	+ N + CMF	

<sup>3)</sup> If the intermediate DC circuit voltage of the drive is increased from the nominal level due to long term resistor braking cycles, check with the motor manufacturer if additional output filters are needed in the applied drive operation range.

### The abbreviations used in the table are defined below

Abbr.	Definition
$U_N$	Nominal AC line voltage.
$\hat{U}_{LL}$	Peak line-to-line voltage at motor terminals which the motor insulation must withstand.
$P_N$	Motor nominal power.
du/dt	du/dt filter at the output of the drive. Available from ABB as an optional add-on kit.
CMF	Common mode filter. Depending on the drive type, CMF is available from ABB as a factory-installed option (+208) or as an optional add-on kit.

N End bearing insulated motor non-drive end bearing.

n/a Motors of this power range are not available as standard units. Consult the motor manufacturer.



NOCH0016-60



NOCH0016-62



NOCH0016-65



FOCH0610-70

**External du/dt filter for ACS880-01, ACS880-11 and ACS880-31**

		du/dt filter type															
		*) 3 filters included, dimensions apply to one filter.															
		Unprotected IP00			Protected to IP22			Protected to IP54									
		NOCH0016-60	NOCH0030-60	NOCH0070-60	NOCH0120-60*)	FOCH0260-70	FOCH0320-50	NOCH0016-62	NOCH0030-62	NOCH0070-62	NOCH0120-62	FOCH0260-72	FOCH0320-52	NOCH0016-65	NOCH0030-65	NOCH0070-65	NOCH0120-65
500 V	690 V																
02A1-5		x						x						x			
03A0-5		x						x						x			
03A4-5		x						x						x			
04A8-5	07A3-7	x						x						x			
05A2-5	07A4-7	x						x						x			
07A6-5	09A8-7	x						x						x			
	09A9-7	x						x						x			
11A0-5	14A2-7	x						x						x			
	14A3-7	x						x						x			
014A-5	018A-7	x						x						x			
	019A-7	x						x						x			
021A-5	022A-7	x						x						x			
	023A-7	x						x						x			
	026A-7	x						x						x			
	027A-7	x						x						x			
027A-5			x						x							x	
034A-5	035A-7		x						x							x	
040A-5	042A-7		x						x							x	
052A-5	049A-7		x						x							x	
			x						x							x	
065A-5	061A-7			x						x							x
077A-5				x						x							x
	084A-7			x						x							x
096A-5	098A-7			x						x							x
124A-5	119A-7				x						x						
156A-5	142A-7				x						x						
180A-5	174A-7				x						x						
240A-5	210A-7				x						x						
260A-5	271A-7				x						x						
					x						x						
361A-5						x						x					
414A-5							x					x					

**External du/dt filter for ACS880 -04/04F, ACS880-14/34 R11 and ACS880-04XT/04FXT \*)**

		FOCH0260-5X	FOCH0320-5X	FOCH0610-7X	FOCH0875-7X	FOCH0260-7X
500 V	690 V					
240A-5	142A-7					x
260A-5	174A-7					x
	210A-7					x
	271A-7					x
		x				
		x				
302A-5			x			
361A-5			x			
414A-5			x			
460A-5	330A-7				x	
503A-5	370A-7				x	
	430A-7				x	
	330A-7				x	
	370A-7				x	
459A-5					x	
460A-5	425A-7				x	
	430A-7				x	
502A-5					x	
503A-5	470A-7				x	
582A-5					x	
583A-5	522A-7				x	
634A-5					x	
635A-5	590A-7				x	
715A-5	650A-7					x
820A-5	721A-7					x
880A-5						x

\*) For ACS880-04XT/FXT one filter per drive module is needed.

**Applicability**

Separate du/dt filters are available for ACS880-01/04/04F/04XT/04FXT/11/31 and -14/34 R11. In addition to these filters, ABB US offers filters from a local filter company. Please contact your local ABB office for further information.

## External du/dt filter for ACS880-104

ACS880-104		NOCH0016-60	NOCH0030-60	NOCH0070-60	BOCH-0350A-7
500 V	690 V				
003A6-5	007A3-7	x			
004A8-5	009A8-7	x			
006A0-5	014A2-7	x			
008A0-5		x			
0011A-5		x			
0014A-5		x			
0018A-5		x			
0025A-5	0018A-7		x		
	0022A-7		x		
0035A-5	0027A-7		x		
	0035A-7			x	
0050A-5	0042A-7			x	
0061A-5	0052A-7			x	
0078A-5				x	
0094A-5				x	
				x	
0110A-5	0062A-7				x
0140A-5	0082A-7				x
0170A-5	0100A-7				x
0200A-5	0130A-7				x
0240A-5	0140A-7				x
0300A-5	0190A-7				x
0340A-5	0220A-7				x
	0270A-7				x

All parallel connected ACS880-104 modules in frame size nxR8i and all 690V ACS880-104 modules in frame size 1xR8i and nxR8i have du/dt filters built-in as standard (+E205). Built-in du/dt filters are available as option (+E205) for ACS880-104 modules in frame size 1xR8i ranging from 380 to 500 V. The built-in du/dt filters in R8i modules do not impact the module dimensions.

## Dimensions and weights of the du/dt filters

du/dt filter	Height [in(mm)]	Width [in(mm)]	Depth [in(mm)]	Weight [lb(kg)]
BOCH-0350A-7 <sup>2)</sup>	12.2(310)	13.7(347)	10.1(256)	35(16)
NOCH0016-60	7.7(195)	5.5(140)	4.5(115)	5(2.4)
NOCH0016-62/65	12.7(323)	7.8(199)	6.1(154)	13(6)
NOCH0030-60	8.5(215)	6.5(165)	5.1(130)	10(4.7)
NOCH0030-62/65	13.7(348)	9.8(249)	6.8(172)	20(9)
NOCH0070-60	10.3(261)	7.1(180)	5.9(150)	21(9.5)
NOCH0070-62/65	17.0(433)	11.0(279)	8.0(202)	34(15.5)
NOCH0120-60 <sup>1)</sup>	7.9(200)	6.1(154)	4.2(106)	15(7)
NOCH0120-62/65	30.1(765)	12.1(308)	10.1(256)	99(45)
FOCH0260-70	15.0(382)	13.4(340)	10.0(254)	104(47)
FOCH0260-72	35.4(900)	12.4(314)	15.1(384)	161(73)
FOCH0320-50	26.1(662)	12.6(319)	11.5(293)	143(65)
FOCH0320-52	43.0(1092)	15.6(396)	16.3(413)	220(100)
FOCH0610-70	26.1(662)	12.6(319)	11.5(293)	143(65)
FOCH0875-70	26.1(662)	12.6(319)	11.5(293)	143(65)

<sup>1)</sup> 3 filters included, dimensions apply to one filter.

<sup>2)</sup> Values are for three single-phase filters.

# Choose the right motor for your application

## Induction motors and the ACS880: a reliable combination

Induction motors are used throughout industry in applications that demand robust and highly reliable motor and drive solutions. ACS880 drives fit perfectly together with this type of motor by providing comprehensive functionality, yet simple operation. The drives are ideal for environments that require a high degree of protection and small footprint. ACS880 drives come with DTC as standard, ensuring high-speed accuracy. ABB motors and drives provide the perfect foundation for energy efficiency, while delivering capabilities such as exceeding the nominal motor speed when maximum power is needed.

Our low voltage motors for explosive atmospheres and low voltage industrial drives have been tested and certified to verify that when correctly sized, they are safe to use in explosive atmospheres. ABB drives can also be used with non-ABB Ex motors with ATEX-certified thermistor protection. If this protection is not used, the motor and drive combination must be either type-tested or combined-tested for potentially explosive atmospheres by the customer, motor manufacturer or a third party. It is also important to verify that the motor can be used with ABB variable speed drives.

## Permanent magnet motors and the ACS880: smooth operation

Permanent magnet technology is used for improved energy efficiency and compactness. This technology is particularly well-suited for low-speed control applications, as in some cases it eliminates the need to use gearboxes. The actual characteristics of different permanent magnet motors can vary considerably. Even without speed or rotor position sensors, ACS880 drives with DTC can control most types of permanent magnet motors.

## IE4 synchronous reluctance motors and the ACS880: optimized energy efficiency

Combining the ACS880's control technology with our synchronous reluctance (SynRM) motors provides an IE4 motor and drive package that ensures high energy efficiency, reduces motor temperatures and provides a significant reduction in motor noise. Lower temperature results in better motor reliability and longer motor life.

ABB has tested our SynRM motor and drive packages and produced manufacturer's statements providing verified system (drive and motor) efficiency.





Traditional IE2 induction motor



IE4 synchronous reluctance motor SynRM

Losses

Induction motor	$I^2R$ Stator	Other	$I^2R$ Rotor	100%
SynRM	$I^2R$ Stator	Other		60%

The idea is simple. Take a conventional, proven stator technology and a totally new, innovative rotor design. Then combine them with a drive loaded with new application-specific software and optimize the whole package for applications such as pumps, fans, compressors, extruders, conveyors and mixers.

Synchronous reluctance technology combines the performance of a permanent magnet motor with the simplicity and service-friendliness of an induction motor. The new rotor has neither magnets nor windings and suffers virtually no

power losses, resulting in high efficiency and lower total cost of ownership. Because the footprints are identical, it is easy to replace an induction motor with a SynRM motor.

IE4 synchronous reluctance motors have very low winding temperatures, which increases the reliability and life of the winding. More importantly, the cooler synchronous reluctance rotor generates significantly lower bearing temperatures. This is an important factor, since bearing failures cause about 70% of unplanned motor outages.





# Keep your process running

From spare parts and technical support to cloud-based remote monitoring solutions, ABB provides the most extensive service offering to fit your needs. Global ABB service is complemented by external authorized value providers from a service network at your doorstep. This service offering can maximize performance, uptime and efficiency throughout the life cycle of your assets.

We can help you more by knowing where you are, register your drive at [www.abb.com/drivereg](http://www.abb.com/drivereg).

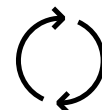

**Replacements**  
Fast and efficient replacement services to minimize production downtime.



**End-of-life services**  
Responsible dismantling, recycling and reusing of products, according to local laws and industrial standards.

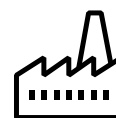

**Maintenance**  
Systematic and organized maintenance and support over the life cycle of your assets.



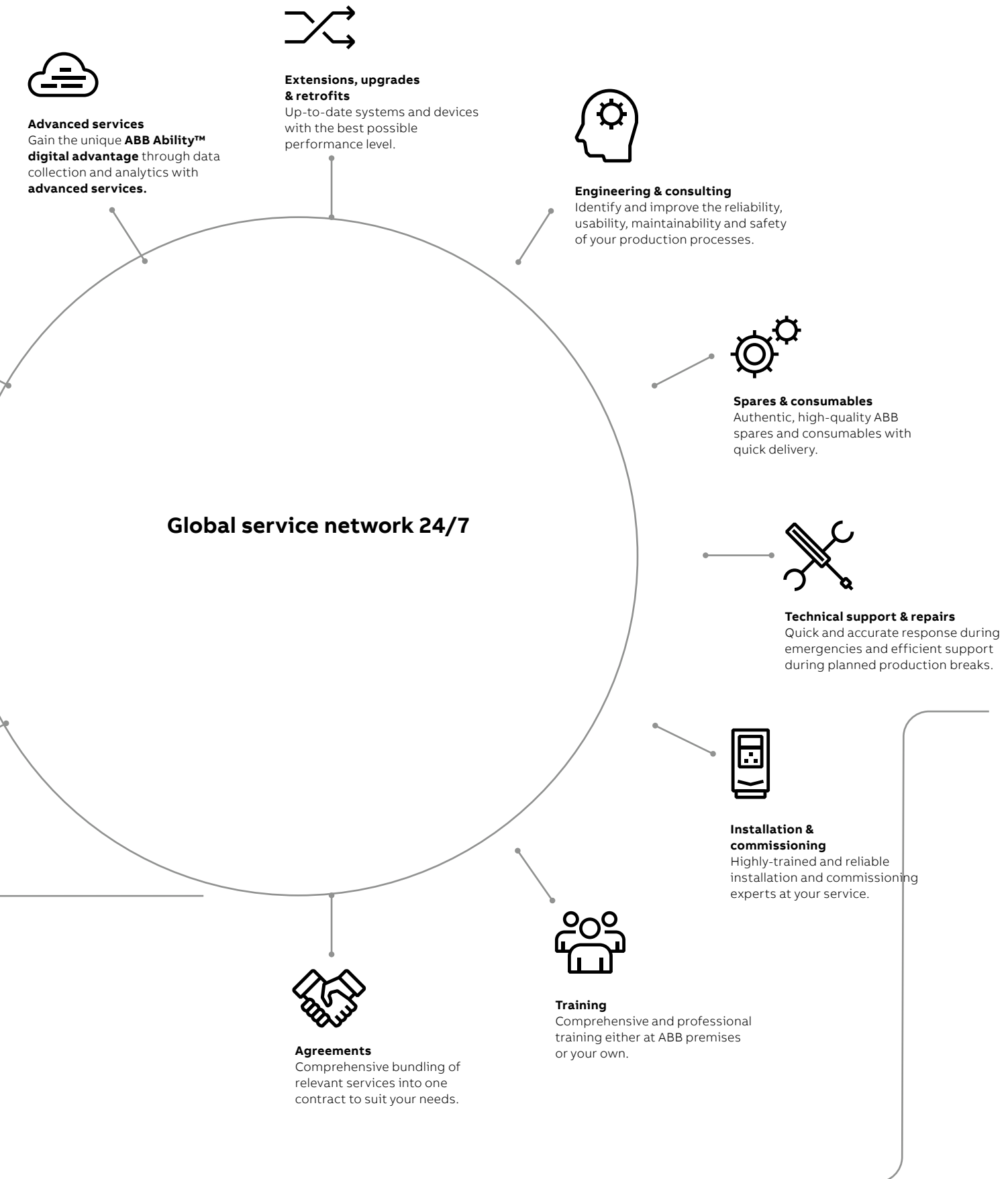



# ABB Ability™ Digital Powertrain

## Intelligent powertrain

The powertrain is equipped with sensors and cloud connectivity and can include motors, drives, mechanical components including bearings, couplings gearboxes and pumps. You can choose what assets you want to monitor.

## Turning data into valuable information

Data gathered from drives' built-in sensors and loggers together with information collected from ABB Ability™ Smart Sensors fitted to motors, bearings and pumps, can be aggregated, stored and further accessed via the cloud. The ability to gather and analyze this data can provide the status and condition of your equipment, allowing you to schedule service activities more effectively.



ABB Ability™ Condition Monitoring service for powertrains optimizes the performance and efficiency of rotating equipment. It enables full transparency on key parameters for drives, motors, mounted bearings and pumps, and can also be used in compressors, conveyors, mixers and extruder applications.

### 3 Accessing data for analytics

You have access to a monitoring portal to view key operational parameters of individual assets as one unified system. Detailed dashboards give full transparency so that you can take actions that lead to less downtime, extended equipment lifetime, lower costs, safer operations and increased profitability.

### 4 Gain a digital advantage

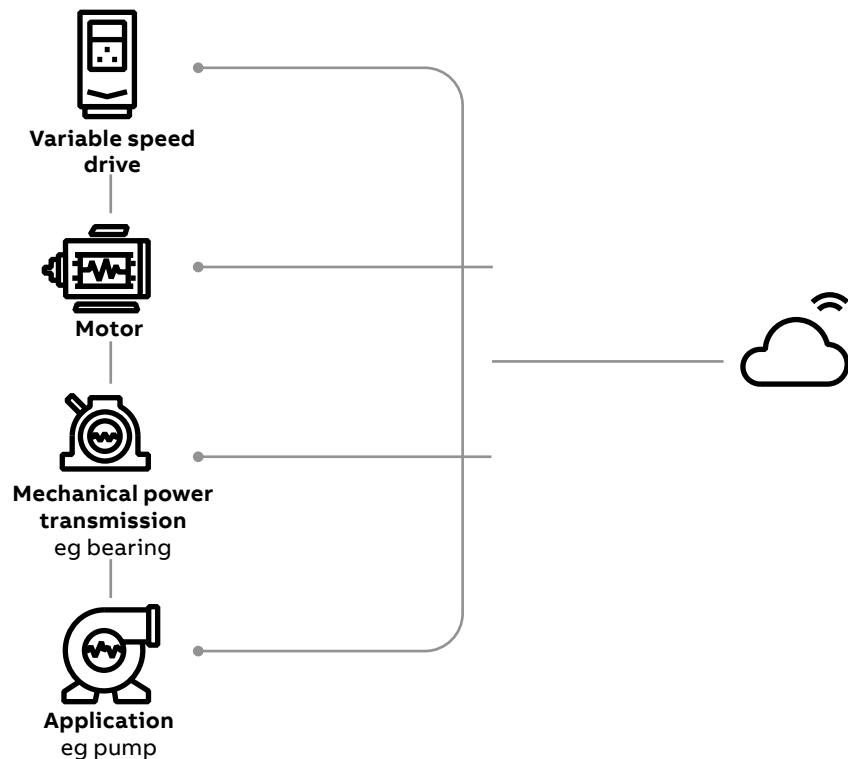
Ensuring that the right person has the right information at the right time brings:

- Appropriate response to production challenges, minimizing operating costs and product waste
- Greater insight into various aspects of your process, thereby improving quality and reducing variations and errors
- Lower risk of production downtime, changes maintenance from reactive to predictive and lowers risk of production downtime



# ACS880 drives are compatible with the wide ABB product offering



## Programmable Logic Controllers PLCs

The AC500, AC500-eCo, AC500-S and AC500-XC scalable PLC ranges provide solutions for small, medium and high-end applications. Our AC500 PLC platform offers different performance levels and is the ideal choice for high availability, extreme environments, condition monitoring, motion control or safety solutions.



## All-compatible drives portfolio

The all-compatible drives share the same architecture; software platform, tools, user interfaces and options.



## AC motors

ABB's low voltage AC motors are designed to save energy, reduce operating costs and minimize unscheduled downtime. General performance motors ensure convenience, while process performance motors provide a broad set of motors for the process industries and heavy-duty applications.



## Automation Builder Engineering suite

ABB Automation Builder is the software for machine builders and system integrators seeking to automate their machines and systems in a unified and efficient way. Automation Builder connects the engineering tools for PLC, safety, control panels, SCADA, drives, motion and robots.



## Control panels

CP600-eCo, CP600 and CP600-Pro control panels offer a wide range of features and functionalities for maximum operability. ABB control panels are distinguished by their robustness and easy usability, providing all the relevant information from production plants and machines at one single touch.



## Jokab safety products

ABB Jokab Safety offers an extensive range of innovative products and solutions for machine safety systems. It is represented in standardization organizations for machine safety and works daily with the practical application of safety requirements in combination with production requirements.

# Summary of features and options

	Ordering code	ACS880-01 +P940/P944 R1 to R9	ACS880-11/31 +P940 R3 to R8	ACS880-04/04F R10 (-04), R11 (-04/04F)	ACS880-04XT 2xR10 to 2xR11	ACS880-04FXT nxR11	ACS880-04 nxDxT + nxR8i	ACS880-14/34 R11	ACS880-14/34 nxR8i + nxR8i
<b>Mounting</b>									
For cabinet mounting	+P940 +P944	□ □	□ -	●	●	●	●	●	●
Mounting direction – bookshelf		●	●	●	●	-	●	●	●
Mounting direction – flat (= sideways)	+C173	-	-	□	■ <sup>1)</sup>	●	■ <sup>1)</sup>	-	■ <sup>1)</sup>
Flange mounting	+C135	□	□	□ <sup>3)</sup>	-	●	-	-	-
Side by side mounting		●	●	●	●	●	●	●	●
External drive control unit		-	-	●	●	●	●	●	●
Integrated drive control unit	+P905	●	●	□ <sup>6)</sup>	-	-	-	-	-
Installation frames for drive modules		-	-	-	-	-	■ <sup>4)</sup>	-	■
Wheels for easy maneuvering of the module		-	-	● <sup>6)</sup>	●	-	●	●	●
<b>Cabling</b>									
Supply bottom entry (module terminals)		●	●	-	-	-	●	-	●
Supply top entry (module terminals)		-	-	●	●	●	-	●	-
Inverter bottom exit (module terminals)		●	●	●	●	●	●	●	●
DC connection bus bars/terminals	+H356	●	●	●	●	●	■	●	■
Cabling panel for quick module installation/removal	+H381	-	-	□ <sup>6)</sup>	■	-	-	□	-
Quick connectors for motor cables		-	-	-	-	-	□	-	□
Right hand side terminals (180 degrees turn)	+H391	-	-	□ <sup>6)</sup>	■	-	-	-	-
<b>Degree of protection</b>									
UL (NEMA) Type Open / IP00	+0B051	-	-	□	●	●	●	□	●
UL (NEMA) Type Open / IP20		●	●	●	■	■	-	●	-
<b>Motor control</b>									
DTC motor control		●	●	●	●	●	●	●	●
<b>Control panel</b>									
Intuitive control panel		● <sup>5)</sup>	● <sup>5)</sup>	●	■	■	■	●	■
Integrated control panel holder in the drive	+J414	●	●	□ <sup>21)</sup>	-	-	-	□	-
Control panel mounting platform DPMP-01 (flush) / DPMP-02 (surface)	+J410/ +J413	■	■	□	■	■	■	□	■
<b>EMC filters</b>									
EMC 1st environment, restricted distribution, C2, grounded network (TN)	+E202	□ <sup>7)</sup>	□ <sup>8)</sup>	□	■ <sup>9)</sup>	■ <sup>9)</sup>	■ <sup>9)</sup>	-	■ <sup>9)</sup>
EMC 2nd environment, C3, grounded network (TN)	+E200	□ <sup>10)</sup>	□	□	□	□	-	- <sup>2)</sup>	-
EMC 2nd environment, C3, ungrounded network (IT)	+E201	□ <sup>12)</sup>	□	□	□	□	-	- <sup>2)</sup>	-
<b>Line filter</b>									
AC or DC choke		●	-	●	●	●	●	-	-
Advanced line harmonic filter (LCL)		-	●	-	-	-	-	●	●
<b>Output filter</b>									
Common mode filter	+E208	□	□	□	●	●	●	□ <sup>11)</sup>	●
Built-in du/dt filters	+E205	-	-	-	-	-	●	-	●
External du/dt filters		■	■	■	■	■	-	■	-
<b>Braking (see braking unit table)</b>									
Brake chopper	+D150	□ <sup>13)</sup>	■	□	□	□	■	<sup>14)</sup>	■
Brake resistor		■	■	■	■	■	■	<sup>14)</sup>	■

- Standard
- Selectable option, with plus code
- Selectable option, external, no plus code

	Ordering code	ACS880-01 +P940/P944 R1 to R9	ACS880-11/31 +P940 R3 to R8	ACS880-04/04F R10 (-04), R11 (-04/04F)	ACS880-04XT 2xR10 to 2xR11	ACS880-04FXT nxR11	ACS880-04 nxDxT + nxR8i	ACS880-14/34 R11	ACS880-14/34 nxR8i + nxR8i
<b>Software</b>									
Primary control program		●	●	●	●	●	●	●	●
Drive application programming based on IEC 61131-3 using Automation Builder (available for primary control program)	+N8010	□	□	□	□	□	□	□	□
Application control program for winder	+N5000	□	14)	□	□	□	□	14)	□
Application control program for crane	+N5050	□	□	□	□	□	□	□	□
Application control program for winch	+N5100	□	□	-	□	□	□	□	□
Application control program for centrifuge/decanter	+N5150	□	□	□	14)	14)	14)	□	14)
Application control program for PCP pump	+N5200	□	□	□	□	□	□	□	□
Application control program for Rod pump	+N5250	□	□	□	14)	14)	-	□	-
Application control program for test bench	+N5300	□	14)	-	□	□	□	14)	□
Application control program for cooling tower direct drive	+N5350	□	14)	□	-	-	-	14)	-
Application control program for override control	+N5450	□	□	□	□	□	□	□	□
Application control program for spinning and traverse	+N5500	□	14)	□	-	-	-	14)	-
Application control program for chemical industry process control	+N5550	□	14)	□	14)	14)	14)	14)	14)
Application control program for ESP pumps	+N5600	□	□	□	□	□	□	□	□
Application control program for tower cranes	+N5650	□	□	□	-	-	-	-	-
Application control program for position control 14)	+N5700	□	□	□	□	□	□	□	□
Support for asynchronous motor		●	●	●	●	●	●	●	●
Support for permanent magnet motor		●	●	●	●	●	●	●	●
Support for synchronous reluctance motor (SynRM)	+N7502	□	□	□	-	-	-	□	-
High speed license. Allows high speed operation above 598 Hz output frequency.	+N8200	□ 17)	-	□ 17)	□ 17)	□ 17)	□ 17)	-	□ 17)
<b>Auxiliary option kits</b>									
Main circuit electrical components		-	-	-	-	-	■	-	■
Installation accessories for Rittal VX25 cabinets		■	■	■	■	■	■	■	■
Installation accessories for generic cabinets		■	■	■	■	■	■	■	■
IP20, IP42 and IP54 door and roof kits		-	-	■	■	■	■	■	■
<b>Approvals</b>									
CE		●	●	●	●	●	●	●	●
UL, cUL		●	●	●	●	14) 17)	●	●	●
CSA		●	●	●	●	14) 17)	●	●	●
EAC/GOST R 15)		●	●	●	●	14) 17)	●	●	●
RoHS		●	●	●	●	●	●	●	●
RCM		●	●	●	-	-	-	●	-
Marine type approvals 16)	+C132	□ 16)	-	● 6)	□ 16)	-	□ 16)	-	□ 16)
TÜV nord certificate for safety functions		●	●	●	●	●	●	●	●
ATEX certified safe disconnection function, Ex II (2) GD (notified body: Eurofins)	+Q971	□	□	□	□	□	□	□	□
SEMI F47		●	●	●	●	●	●	●	●

● Standard

□ Selectable option, with plus code

Selectable option, with plus code

	Ordering code	ACS880-01 +P940/P944 R1 to R9	ACS880-11/31 +P940 R3 to R8	ACS880-04/04F R10 (-04), R11 (-04/04F)	ACS880-04XT 2xR10 to 2xR11	ACS880-04FXT nxR11	ACS880-04 nxDxT + nxR8i	ACS880-14/34 R11	ACS880-14/34 nxR8i + nxR8i
<b>Safety functions</b> <sup>20)</sup>									
Safe torque off (STO)		●	●	●	●	●	●	●	●
Safety functions module, FSO-12, without encoder, configurable functions:									
- Safe stop 1 (SS1-t, SS1-r)									
- Safely-limited speed (SLS)									
- Safe brake control (SBC)	+Q973	□	□	□	■	■	■	□	■
- Safe maximum speed (SMS)									
- Safe stop emergency (SSE)									
- Prevention of unexpected start-up (POUS)									
- Safe torque off (STO)									
Safety functions module, FSO-21, with encoder support, configurable functions:									
- Safe stop 1 (SS1-t, SS1-r)									
- Safely-limited speed (SLS)									
- Safe brake control (SBC)									
- Safe maximum speed (SMS)	+Q972	□	□	□	■	■	■	□	■
- Safe stop emergency (SSE)									
- Prevention of unexpected start-up (POUS)									
- Safe direction (SDI), requires encoder feedback, FSE-31									
- Safe speed monitoring (SSM)									
- Safe torque off (STO)									
Pulse encoder interface module, FSE-31	+L521	□	□	□	■	■	■	□	■
PROFIsafe over PROFINET	+Q982	□	□	□	■	■	■	□	■
ATEX certified thermistor protection module, FPTC-02, Ex II (2) GD <sup>21)</sup>	+L537 +Q971	□	□	□	■	■	■	□	■
<b>Earth fault protection</b>									
Earth fault monitoring, earthed mains		●	●	●	●	●	●	●	●
● Standard									
□ Selectable option, with plus code									
■ Selectable option, external, no plus code									

Ordering code	ACS880-01 +P940/P944 R1 to R9	ACS880-11/31 +P940 R3 to R8	ACS880-04/04F R10 (-04), R11 (-04/04F)	ACS880-04XT 2xR10 to 2xR11	ACS880-04FXT nxR11	ACS880-04 nxDxT + nxR8i	ACS880-14/34 R11	ACS880-14/34 nxR8i + nxR8i	
<b>Control connections (I/O) and communications</b>									
2 pcs analog inputs, programmable, galvanically isolated	●	●	●	●	●	●	●	●	
2 pcs analog outputs, programmable	●	●	●	●	●	●	●	●	
6 pcs digital inputs, programmable, galvanically isolated – can be divided into two groups	●	●	●	●	●	●	●	●	
2 pcs digital inputs/outputs	●	●	●	●	●	●	●	●	
1 pcs digital input interlock	●	●	●	●	●	●	●	●	
3 pcs relay outputs programmable	●	●	●	●	●	●	●	●	
Drive-to-drive link/Built-in Modbus	●	●	●	●	●	●	●	●	
Assistant control panel/PC tool connection	●	●	●	●	●	●	●	●	
Possibility for external power supply for control unit	●	●	●	●	●	●	●	●	
Built-in I/O extension and speed feedback modules: for more details see sections: "Input/output extension modules", "Speed feedback interfaces for precise process control" and "DDCS communication option modules" <sup>18)</sup>	□	□	□	■	■	■	□	■	
Built-in adapters for several communication protocols: for more details see section "Communication protocol adapters" <sup>19)</sup>	□	□	□	■	■	■	□	■	

● Standard

□ Selectable option, with plus code

■ Selectable option, external, no plus code

– Not available

<sup>1)</sup> The drive must be installed according to the instructions given in the manuals.

<sup>2)</sup> Available with +E210.

<sup>3)</sup> Only for ACS880-04F

<sup>4)</sup> Only for 6-pulse D8T module

<sup>5)</sup> Without control panel, +0J400

<sup>6)</sup> Not for ACS880-04F

<sup>7)</sup> For frame sizes R1 to R9, 380 to 500 V. Not for 690 V.

<sup>8)</sup> +E202 for frame size R6: Please contact your local ABB office to check availability.

<sup>9)</sup> For 380 to 500 V and only for frame size 1xD8T (-04 module packages) and for frame size 1xR8i (-14/34 module packages)

<sup>10)</sup> For frame sizes R1 to R9, 380 to 500 V and frame sizes R3 to R9, 690 V.

<sup>11)</sup> As standard for 690 V.

<sup>12)</sup> For frame sizes R6 to R9, 380 to 500 V and frame sizes R7 to R9, 690 V.

<sup>12)</sup> 2<sup>nd</sup> environment, C4: Frame sizes R1 to R5, 380 to 500 V and frame sizes R3 to R6, 690 V.

<sup>13)</sup> Frame sizes R1 to R4 built-in and R5 to R9 as selectable option

<sup>14)</sup> Pending

<sup>15)</sup> EAC has replaced GOST R

<sup>16)</sup> ACS880 marine type approvals and type approved drives are listed at <http://new.abb.com/drives/segments/marine/marine-type-approvals>.

<sup>17)</sup> For further information, please contact your local ABB office.

<sup>18)</sup> Three option slots are available for I/O extension, speed feedback, communication protocol and functional safety options.

The slot number for I/O and encoder options can be extended with FEA-03 option.

<sup>19)</sup> Three option slots are available for I/O extension, speed feedback, communication protocol and functional safety options.

<sup>20)</sup> Three option slots are available for I/O extension, speed feedback, communication protocol and functional safety options.

FSO-xx can also be mounted on a DIN rail by using a separate installation kit. DIN rail mounting does not consume the drive's option slots.

With frames R6 to R11 it is possible to mount the FSO-xx inside the drive without using the drive's option slots.

<sup>21)</sup> Contact ABB for extended lead time



Ordering code	ACS880-104 INU R1i to nxR8i	ACS880-204 ISU R1i to R4i, R6i and nxR8i	ACS880-304 DSU D6D to D8D	ACS880-304 DSU 2xD7T and nxD8T	ACS880-904 RRU nxR8i	ACS880-604 nxR8i	ACS880-1604 nxR8i	ACS880-104LC nxR8i	ACS880-204LC nxR8i	ACS880-304LC nxD8D	ACS-1604LC nxR8i
<b>Mounting</b>											
For cabinet mounting	●	●	●	●	●	●	●	●	●	●	●
Mounting direction – bookshelf	●	●	●	●	●	●	●	●	●	●	●
Mounting direction – flat (= sideways)	■ <sup>1)</sup>	■ <sup>1)</sup>	■ <sup>1)</sup>	■ <sup>1)</sup>	■ <sup>1)</sup>	■ <sup>1)</sup>	■ <sup>1)</sup>	–	–	–	–
Flange mounting	–	–	–	–	–	–	–	–	–	–	–
Side by side mounting	●	●	–	●	●	●	●	●	●	●	●
External drive control unit	● <sup>2)</sup>	● <sup>2)</sup>	●	●	●	●	●	●	●	●	●
Integrated drive control unit	● <sup>3)</sup>	● <sup>3)</sup>	–	–	–	–	–	–	–	–	–
Installation frames for drive modules	■ <sup>5)</sup>	■ <sup>5)</sup>	–	■ <sup>5)</sup>	–	–	–	–	–	–	–
Wheels for easy maneuvering of the module	● <sup>6)</sup>	● <sup>6)</sup>	● <sup>6)</sup>	● <sup>6)</sup>	●	● <sup>6)</sup>	●	–	–	–	–
<b>Cabling</b>											
Supply bottom entry (module terminals)	–	●	●	●	●	●	●	–	●	●	●
Supply top entry (module terminals)	–	–	–	–	–	–	–	–	–	–	–
Inverter bottom exit (module terminals)	●	–	–	–	–	●	●	●	–	–	●
DC connection bus bars/terminals	■ <sup>8)</sup>	■ <sup>8)</sup>	■	■	■	■	■	■	■	■	■
<b>Degree of protection</b>											
UL (NEMA) Type Open / IP00	●	●	●	●	●	●	●	●	●	●	●
UL (NEMA) Type Open / IP20	–	–	–	–	–	–	–	–	–	–	–
<b>Motor control</b>											
DTC motor control	●	–	–	–	–	–	–	●	–	–	–
<b>Control panel</b>											
Intuitive control panel	■	■	■	■	■	■	■	■	■	■	■
Integrated control panel holder in the drive	– <sup>8)</sup>	– <sup>8)</sup>	–	–	–	–	–	–	–	–	–
Control panel mounting platform DPMP-01 (flush) / DPMP-02 (surface)	■	■	■	■	■	■	■	■	■	■	■
<b>EMC filters</b>											
EMC 1st environment, restricted distribution, C2, grounded network (TN)	–	■ <sup>14)</sup>	–	■ <sup>14)</sup>	–	–	–	–	–	–	–
EMC 2nd environment, C3, grounded (TN) and ungrounded (IT)	● <sup>15)</sup>	● <sup>15)</sup>	● <sup>15)</sup>	● <sup>15)</sup>	● <sup>15)</sup>	● <sup>15)</sup>	● <sup>15)</sup>	● <sup>15)</sup>	● <sup>15)</sup>	● <sup>15)</sup>	● <sup>15)</sup>
<b>Line filter</b>											
AC or DC choke	–	–	●	●	–	–	–	–	–	–	–
Advanced line harmonic filter LCL	–	●	–	–	–	–	–	–	●	–	–
L	–	–	–	–	●	–	–	–	–	–	–
<b>Output filter</b>											
Common mode filter	● <sup>16)</sup>	● <sup>9)</sup>	–	–	●	●	–	●	●	–	–
Built-in du/dt filters	+E205 □ <sup>4)</sup>	● <sup>4)</sup>	–	–	● <sup>4)</sup>	● <sup>4)</sup>	● <sup>4)</sup>	●	● <sup>4)</sup>	–	● <sup>4)</sup>
External du/dt filters	■	–	–	–	–	–	–	–	–	–	–
<b>Braking (see braking unit table)</b>											
Brake chopper	■ <sup>17)</sup>	–	–	–	–	●	–	–	–	–	–
Brake resistor	■	–	–	–	–	■	–	–	–	–	–
Regenerative braking	–	●	–	–	●	–	–	–	●	–	–

● Standard

□ Selectable option, with plus code

■ Selectable option, external, no plus code

	Ordering code	ACS880-104 INU R1i to nxR8i	ACS880-204 ISU R1i to R4i, R6i and nxR8i	ACS880-304 DSU D6D to D8D	ACS880-304 DSU 2xD7T and nxD8T	ACS880-904 RRU nxR8i	ACS880-604 nxR8i	ACS880-1604 nxR8i	ACS880-104LC nxR8i	ACS880-204LC nxR8i	ACS880-304LC nxR8i	ACS880-1604LC nxR8i
<b>Software</b>												
Primary control program		●	-	-	-	-	-	-	●	-	-	-
Drive application programming based on IEC 61131-3 using Automation Builder	+N8010	□	□	-	-	-	-	-	□	□	-	-
Application control program for winder	+N5000	□	-	-	-	-	-	-	-	-	-	-
Application control program for crane	+N5050	□	-	-	-	-	-	-	□	-	-	-
Application control program for winch	+N5100	□	-	-	-	-	-	-	□	-	-	-
Application control program for centrifuge/decanter	+N5150	- <sup>7)</sup>	-	-	-	-	-	-	-	-	-	-
Application control program for PCP pump	+N5200	□	-	-	-	-	-	-	-	-	-	-
Application control program for Rod pump	+N5250	-	-	-	-	-	-	-	-	-	-	-
Application control program for test bench	+N5300	□	-	-	-	-	-	-	□	-	-	-
Application control program for cooling tower direct drive	+N5350	-	-	-	-	-	-	-	-	-	-	-
Application control program for override control	+N5450	-	-	-	-	-	-	-	-	-	-	-
Application control program for spinning and traverse	+N5500	-	-	-	-	-	-	-	-	-	-	-
Application control program for chemical industry process control	+N5550	- <sup>7)</sup>	-	-	-	-	-	-	-	-	-	-
Application control program for ESP pumps	+N5600	□	-	-	-	-	-	-	-	-	-	-
Application control program for tower cranes	+N5650	-	-	-	-	-	-	-	-	-	-	-
Application control program for position control	+N5700	□	-	-	-	-	-	-	□	-	-	-
Support for asynchronous motor		●	-	-	-	-	-	-	●	-	-	-
Support for permanent magnet motor		●	-	-	-	-	-	-	●	-	-	-
Support for synchronous reluctance motor (SynRM)	+N7502	□	-	-	-	-	-	-	-	-	-	-
Optimal grid control of IGBT supply control program (grid converter)	+N8053	-	□ <sup>4) 11)</sup>	-	-	-	-	-	-	□ <sup>4) 11)</sup>	-	-
High speed license. Allows high speed operation above 598 Hz output frequency.	+N8200	□ <sup>11)</sup>	-	-	-	-	-	-	- <sup>7)</sup>	-	-	-
<b>Auxiliary option kits</b>												
Main circuit electrical components		■	■	■	■	■	■	■	■	■	■	■
DC-fuse switch		■	-	-	-	-	-	■	■	■	-	■
Installation accessories for Rittal VX25 cabinet		■	■	■	■	■	■	■	■	■	■	■
Installation accessories for generic cabinets		■	■	■	■	■	■	■	■	■	■	■
IP20, IP42 and IP54 door and roof kits		■	■	■	■	■	■	■	-	-	-	-
<b>Approvals</b>												
CE		●	●	●	●	●	●	●	●	●	●	●
UL, cUL		●	●	● <sup>22)</sup>	● <sup>22)</sup>	●	●	●	● <sup>7)</sup>	● <sup>7)</sup>	● <sup>7)</sup>	● <sup>7)</sup>
CSA		●	●	● <sup>22)</sup>	● <sup>22)</sup>	●	●	●	● <sup>7)</sup>	● <sup>7)</sup>	● <sup>7)</sup>	● <sup>7)</sup>
EAC/GOST R <sup>10)</sup>		●	●	●	●	●	●	●	● <sup>7)</sup>	● <sup>7)</sup>	● <sup>7)</sup>	● <sup>7)</sup>
RoHS		●	●	●	●	●	●	●	●	●	●	●
RCM		-	-	-	-	-	-	-	-	-	-	-
Marine type approvals <sup>19)</sup>	+C132	□ <sup>19, 20)</sup>	□ <sup>19, 20)</sup>	-	□ <sup>19)</sup>	-	□ <sup>19)</sup>	□ <sup>19)</sup>	□ <sup>19)</sup>	□ <sup>19)</sup>	□ <sup>19)</sup>	□ <sup>19)</sup>
TÜV nord certificate for safety functions		●	-	-	-	-	-	-	●	-	-	-
ATEX certified safe disconnection function, Ex II (2) GD (notified body: Eurofins)	+Q971	□	-	-	-	-	-	-	□	-	-	-
SEMI F47		●	●	●	●	●	-	●	●	●	●	●

● Standard  
 □ Selectable option, with plus code  
 ● Selectable option, with plus code and plus code

Ordering code	ACS880-104 INU R1i to nxR8i	ACS880-204 ISU R1i to R4i, R6i and nxR8i	ACS880-304 DSU D6D to D8D	ACS880-304 DSU 2xD7T and nxD8T	ACS880-904 RRU nxR8i	ACS880-604 nxR8i	ACS880-1604 nxR8i	ACS880-104LC nxR8i	ACS880-204LC nxR8i	ACS880-304LC nxD8D	ACS-1604LC nxR8i	
<b>Safety functions <sup>13)</sup></b>												
Safe torque off (STO)	●	–	–	–	–	–	–	●	–	–	–	
Safety functions module, FSO-12, without encoder, configurable functions:	■	–	–	–	–	–	–	■	–	–	–	
- Safe stop 1 (SS1-t, SS1-r)												
- Safely-limited speed (SLS)												
- Safe brake control (SBC)												
- Safe maximum speed (SMS)												
- Safe stop emergency (SSE)												
- Prevention of unexpected start-up (POUS)												
- Safe torque off (STO)												
Safety functions module, FSO-21, with encoder support, configurable functions:	■	–	–	–	–	–	–	■	–	–	–	
- Safe stop 1 (SS1-t, SS1-r)												
- Safely-limited speed (SLS)												
- Safe brake control (SBC)												
- Safe maximum speed (SMS)												
- Safe stop emergency (SSE)												
- Prevention of unexpected start-up (POUS)												
- Safe direction (SDI), requires encoder feedback, FSE-31												
- Safe speed monitoring (SSM)												
- Safe torque off (STO)												
Pulse encoder interface module, FSE-31	■	–	–	–	–	–	–	■	–	–	–	
PROFIsafe safety functions module, FSFS-21	■	–	–	–	–	–	–	■	–	–	–	
PROFIsafe over PROFINET	■	–	–	–	–	–	–	■	–	–	–	
ATEX certified thermistor protection module, Ex II (2) GD	FPTC-02 +Q971	■	–	–	–	–	–	■	–	–	–	

**Earth fault protection**

Earth fault monitoring, earthed mains

- Standard
- Selectable option, with plus code
- Selectable option, external, no plus code

Ordering code	ACS880-104 INU R1i to nxR8i	ACS880-204 ISU R1i to R4i, R6i and nxR8i	ACS880-304 DSU D6D to D8D	ACS880-304 DSU 2xD7T and nxD8T	ACS880-904 RRU nxR8i	ACS880-604 nxR8i	ACS880-1604 nxR8i	ACS880-104LC nxR8i	ACS880-204LC nxR8i	ACS880-304LC nxR8i	ACS-1604LC nxR8i
---------------	-----------------------------	--	---------------------------	--------------------------------	----------------------	------------------	-------------------	--------------------	--------------------	--------------------	------------------

**Control connections (I/O) and communications**

2 pcs analog inputs, programmable, galvanically isolated	●	●	●	●	●	● <sup>12)</sup>	●	●	●	●	●
2 pcs analog outputs, programmable	●	●	●	●	●	● <sup>12)</sup>	●	●	●	●	●
6 pcs digital inputs, programmable, galvanically isolated – can be divided into two groups	●	●	●	●	●	● <sup>12)</sup>	●	●	●	●	●
2 pcs digital inputs/outputs	●	●	●	●	●	● <sup>12)</sup>	●	●	●	●	●
1 pcs digital input interlock	●	●	●	●	●	● <sup>12)</sup>	●	●	●	●	●
3 pcs relay outputs programmable	●	●	●	●	●	● <sup>12)</sup>	●	●	●	●	●
Drive-to-drive link/Built-in Modbus	●	●	●	●	●	● <sup>12)</sup>	●	●	●	●	●
Assistant control panel/PC tool connection	●	●	●	●	●	● <sup>9)</sup>	●	●	●	●	●
Possibility for external power supply for control unit	●	●	●	●	●	●	●	●	●	●	●
Built-in I/O extension and speed feedback modules: for more details see sections: "Input/output extension modules", "Speed feedback interfaces for precise process control" and "DDCS communication option modules" <sup>18)</sup>	■	■	■	■	■	■	■	■	■	■	■
Built-in adapters for several communication protocols: for more details see section "Communication protocol adapters" <sup>21)</sup>	■	■	■	■	■	■	■	■	■	■	■

- Standard
- Selectable option, with plus code
- Selectable option, external, no plus code
- Not available

<sup>1)</sup> The drive must be installed according to the instructions given in the manuals. Possible for frames R6i-R8i, DxD, DxT, BLCL-, BL- and BDCL-filters.

<sup>2)</sup> R1i to R7i on the module

<sup>3)</sup> R8i as external

<sup>4)</sup> Only for R8i module.

<sup>5)</sup> Only for R6i-R8i modules, 6-pulse DxT modules and BLCL-filters

<sup>6)</sup> R1i-R7i, D6D, D7D and D7T modules and 1-phase brake chopper without wheels

<sup>7)</sup> Pending

<sup>8)</sup> R1i to R5i as standard

<sup>9)</sup> Available for R8i and R6i

<sup>10)</sup> EAC has replaced GOST R

<sup>11)</sup> For further information, please contact your local ABB office.

<sup>13)</sup> Three option slots are available for I/O extension, speed feedback, communication protocol and functional safety options. FSO-xx can also be mounted on a DIN rail by using a separate installation kit. DIN rail mounting does not consume the drives' option slots.

<sup>12)</sup> Not available for 1-phase brake unit.

<sup>14)</sup> For 380 to 500 V and for ISU frame sizes up to 1xR8i and for 1xD8T

<sup>15)</sup> The standard module fulfills C3 requirements when installed according to the instructions given in the manuals.

<sup>16)</sup> Available for R6i to R8i

<sup>17)</sup> Internal with R1i to R4i

<sup>18)</sup> Three option slots are available for I/O extension, speed feedback, communication protocol and functional safety options. The slot number for I/O and encoder options can be extended with FEA-03 option.

<sup>19)</sup> ACS880 marine type approvals and type approved drives are listed at <http://new.abb.com/drives/segments/marine/marine-type-approvals>.

<sup>20)</sup> ACS880-104 and ACS880-204 frames R1i-R4i do not have marine type approval (+C132).

<sup>21)</sup> Three option slots are available for I/O extension, speed feedback, communication protocol and functional safety options.

<sup>22)</sup> Frames D8D and D8T have a selectable option for UL, cUL and CSA approved modules





—  
For more information, please contact  
your local ABB representative or visit

**[new.abb.com/ACS880](http://new.abb.com/ACS880)**  
**[new.abb.com/drives](http://new.abb.com/drives)**  
**[new.abb.com/drivespartners](http://new.abb.com/drivespartners)**  
**[new.abb.com/motors-generators](http://new.abb.com/motors-generators)**

Video playlist:  
ACS880 how-to videos

